

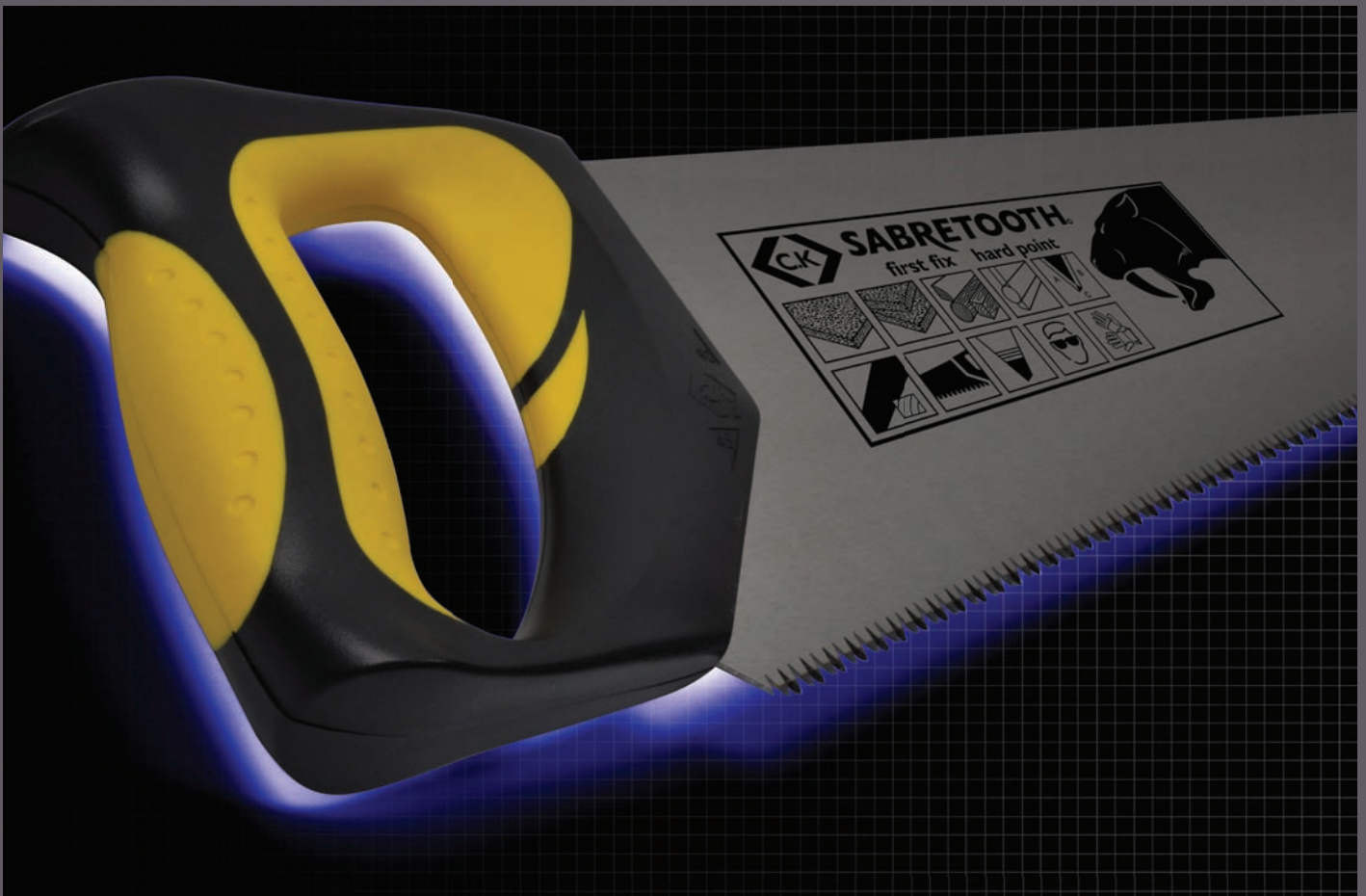

C.K TOOLS

PRODUCT RANGE

Version 1





DESIGNED FOR PROFESSIONALS
QUALITY
INNOVATION
BRAND LEADERSHIP

For over 100 years, C.K has been at the forefront of hand tool manufacturing, producing high quality tools that meet the most demanding needs of trade professionals.

Backed by a lifetime guarantee, C.K tools are engineered to offer leading performance, durability, accuracy and strength, all of which are key requirements for professional results. Not content with simply conforming to all relevant international standards, C.K work with metallurgical and design engineers to develop new materials, manufacturing techniques and finishing treatments to push the boundaries of performance.

Driven by research through an extensive panel of cross trade professionals, tools are developed to assist with every day tasks; an approach proven to produce innovative tools that transform traditional working practices.

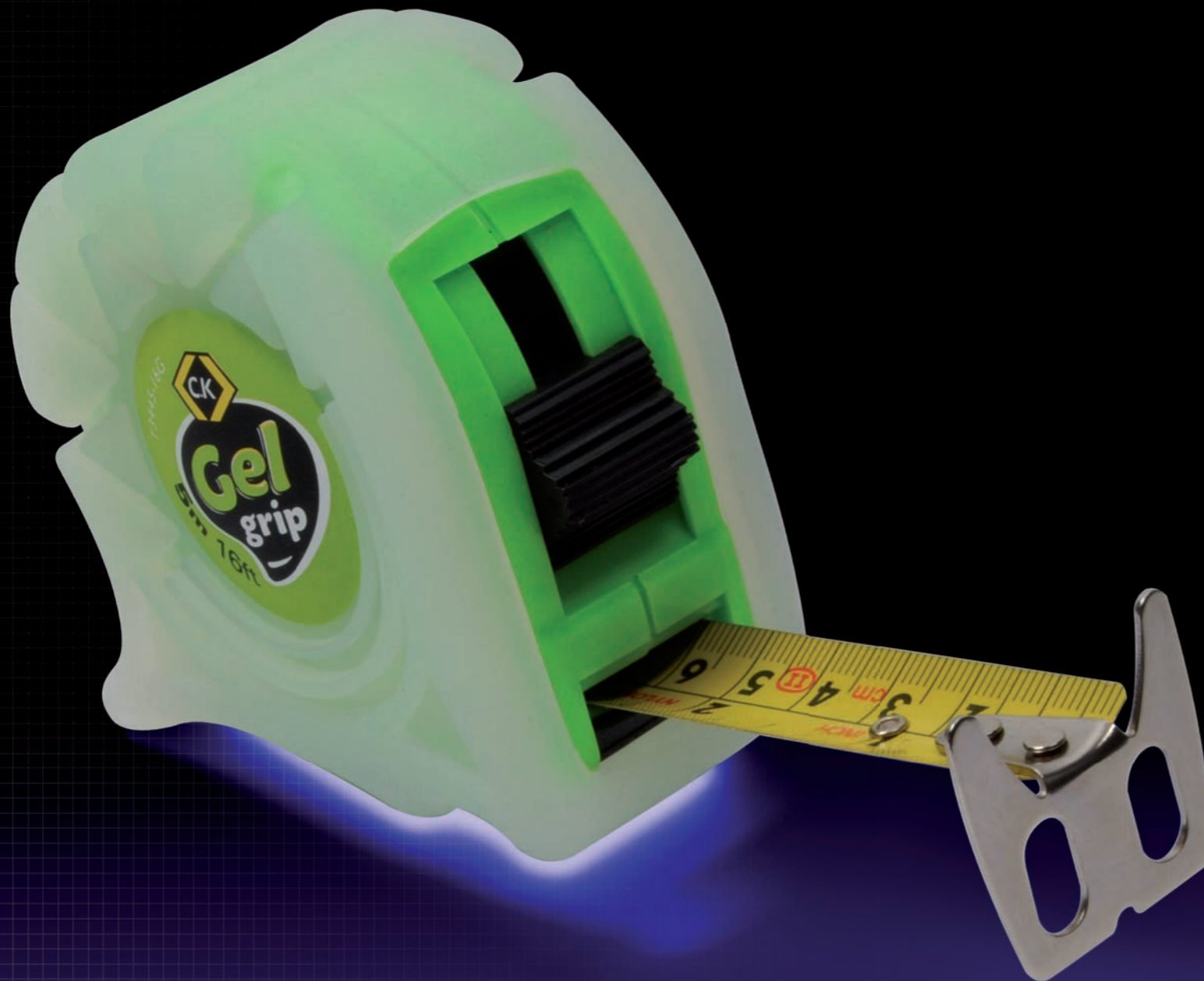

ENTWICKELT FÜR FACHLEUTE
PRODUKTQUALITÄT
INNOVATION
MARKENFÜHRER

CONÇU POUR LES PROFESSIONNELS
QUALITÉ DES PRODUITS
INNOVATION
RENOMMÉE DE LA MARQUE

DISEÑADO PARA PROFESIONALES
CALIDAD DEL PRODUCTO
INNOVACIÓN
LIDERAZGO DE MARCA

Seit über 100 Jahren steht C.K an vorderster Front der Handwerkzeugherstellung und fertigt hochqualitative Werkzeuge, die den anspruchsvollsten Bedarf von Fachleuten erfüllen.

Mit einer lebenslangen Garantie versehen sind C.K-Werkzeuge führend in Leistung, Dauerhaftigkeit, Genauigkeit und Beanspruchung - all das sind Schlüsselanforderungen für professionelle Ergebnisse. Neben der Übereinstimmung mit allen einschlägigen internationalen Standards arbeitet C.K mit Metallurgen und Ingenieuren an der Entwicklung neuer Werkstoffe, Technologien und Oberflächenbehandlungen, um die Leistungsgrenzen weiter nach oben zu verschieben.

Unterstützt durch die Zusammenarbeit mit einem großen Kreis von berufsübergreifender Fachleuten werden Werkzeuge entwickelt, die zur Umsetzung von täglichen Aufgaben einen erheblichen Beitrag leisten.

Depuis plus de 100 ans, C.K est une entreprise de premier plan dans la fabrication d'outils à main de haute qualité qui répondent aux besoins les plus contraignants des utilisateurs professionnels.

Bénéficiant d'une garantie à vie, les outils C.K sont mis au point techniquement pour offrir performances de pointe, durabilité, exactitude et résistance, autant d'exigences essentielles pour des résultats professionnels.

Ne se contentant pas de se conformer à l'ensemble des normes internationales en vigueur dans ce domaine, C.K travaille avec des ingénieurs métallurgistes et des bureaux d'études à l'élaboration de nouveaux matériaux, de nouvelles techniques de fabrication et de nouveaux traitements de finition afin de repousser les limites de ses outils en termes de performance.

Fruit d'enquêtes menées auprès d'un panel interprofessionnel étendu, les outils sont élaborés dans l'optique de faciliter les tâches quotidiennes ; une démarche concrétisée par la réalisation d'outils innovants qui transforment les méthodes de travail traditionnelles.

Durante más de 100 años, CK ha estado a la vanguardia de la fabricación de herramientas manuales, produciendo herramientas de alta calidad que satisfagan las necesidades más exigentes de los profesionales del sector.

Respaldadas por una garantía de por vida, las herramientas de CK están diseñadas para ofrecer un rendimiento, durabilidad, precisión y resistencia inmejorables, todos ellos requisitos fundamentales para obtener resultados profesionales.

No nos contentamos simplemente en cumplir con todos los estándares internacionales pertinentes, en CK, además, trabajamos con diseñadores e ingenieros metalúrgicos para desarrollar nuevos materiales, nuevas técnicas de fabricación y nuevos tratamientos de acabado para ampliar los límites del rendimiento.

Motivados por la investigación a través de un amplio panel de profesionales del sector, hemos desarrollado herramientas que nos ayudan en las tareas diarias, un método de probada eficacia para fabricar herramientas innovadoras que transformen las prácticas de trabajo tradicionales.

















With an established reputation for premium quality, innovative products, C.K tools are the trusted choice of trade professionals. Supported with advanced marketing techniques designed to drive demand and maximize sales, C.K continues to strengthen its brand leadership throughout the world.

Die Premium-Qualität unserer innovativen Produkte macht C.K-Werkzeuge zur ersten Wahl bei Fachleuten. Darüber hinaus unterstützt modernstes Marketing den weltweiten Verkauf und untermauert die führende Position von C.K in den internationalen Märkten.

Avec une réputation établie de qualité supérieure et de produits innovants, C.K tools est une marque d'outillage que les utilisateurs professionnels choisissent en toute confiance. Prenant appui sur des techniques commerciales évoluées conçues pour stimuler la demande et optimiser les ventes, l'entreprise C.K continue à renforcer la renommée de sa marque à travers le monde.

Con una sólida reputación de fabricar productos de alta calidad e innovadores, las herramientas de CK son la elección de confianza de los profesionales del sector. Gracias a las técnicas avanzadas de marketing diseñadas para impulsar la demanda y maximizar las ventas, CK sigue fortaleciendo su liderazgo de marca en todo el mundo.

CONTENTS . INHALT . CONTENU . CONTENIDO

| | | | |
|---|---|---|--|
|  | PLIERS & CUTTERS ZANGEN SCHNEIDWERKZEUGE PINCES ALICATES Y CORTADORE |  | ENGINEER'S TOOLS MECHANIKERWERKZEUGE OUTILS MECHANIQUES HERRAMIENTAS DE MECÁNICO |
| 6-27 | | 104-111 | |
|  | SCREWDRIVERS SCHRAUBENDREHER TOURNEVIS DESTORNILLADORES |  | POWER TOOL ACCESSORIES ELEKTROWERKZEUGE - ZUBEHÖR ACCESSOIRES POUR OUTILS ÉLECTRIQUES ACCESORIOS PARA HERRAMIENTAS MOTORIZADAS |
| 28-47 | | 112-135 | |
|  | ELECTRICIAN'S TOOLS ELEKTRIKERWERKZEUGE AUTRES OUTILS D'ELECTRICIEN HERRAMIENTAS DE ELECTRICISTA |  | WATER SYSTEMS WASSERSYSTEME RÉSEAUX D'ALIMENTATION EN EAU SISTEMAS DE AGUA |
| 48-57 | | 136-141 | |
|  | BUILDING & PLUMBING BAU UND SANITÄRINSTALLATION BÂTIMENT ET PLOMBERIE CONSTRUCCIÓN Y FONTANERÍA |  | ESD & PRECISION ESD- & PRÄZISIONSWERKZEUGE OUTILS DE PRÉCISION & ESD ESD Y HERRAMIENTAS DE PRECISIÓN |
| 58-75 | | 142-172 | |
|  | MEASURING & MARKING MESSEN & MARKIEREN MESURE & MARQUAGE MEDICIÓN Y MARCADO |  | POINT OF SALE VERKAUFSBEREICH MATERIAL PLV PUNTO DE VENTA |
| 76-85 | | 173-176 | |
|  | SAWING & CUTTING SÄGEN & SCHNEIDEN SCIAGE ET DÉCOUPE ASERRADO Y CORTADO |  | MERCHANDISING ABSATZFÖRDERUNG MERCHANDISING COMERCIALIZACIÓN |
| 86-93 | | 177-180 | |
|  | SOCKETS, SPANNERS & WRENCHES STECKSCHLÜSSEL & SCHRAUBENSCHLÜSSEL DOUILLES ET CLÉS CASQUILLOS, LLAVES DE TUERCAS Y LLAVES INGLESAS |  | INDICES & ICON KEY INDEX & LEGENDE INDEX ET LÉGENDES INDICE E ICONOS |
| 94-103 | | 181-188 | |

REDLINE VDE

REDLINE VDE
REDLINE VDE
REDLINE VDE

8-13

REDLINE

REDLINE
REDLINE
REDLINE

14-16

CLASSIC

CLASSIC
CLASSIC
CLASSIC

17-18

WATERPUMP PLIERS

WASSERPUMPENZANGEN
PINCES MULTIPRISES
LLAVES CORREDIZAS

18-19

CRIMPING PLIERS

CRIMPZANGEN
PINCES À SERTIR
ALICATES PARA ENGASTADO

20-22

CIRCLIP PLIERS

SICHERUNGSRINGZANGEN
PINCES À CIRCLIPS
ALICATES DE SUJECIÓN

23

RIVETING PLIERS & RIVETS

BLINDNIETZANGEN UND NIETEN
PINCES À RIVETER ET RIVETS
ALICATES DE REMACHE Y REMACHES

24-25

PVC CUTTERS

PVC-SCHNEIDER
PINCES COUPANTES POUR PVC
ALICATES DE CORTE PVC

25

PINCERS & TOP CUTTERS

KNEIFZANGEN UND VORNSCHNEIDER
TENAILLES ET PINCES COUPANTES DEVANT
PINZAS Y ALICATES DE CORTE

26

HEAVY DUTY CUTTERS

KRAFTSEITENSCHNEIDER
PINCES COUPANTES HAUTES PERFORMANCES
ALICATES DE CORTE PARA TRABAJOS PESADOS

27

PLIERS & CUTTERS

ZANGEN SCHNEIDWERKZEUGE
PINCES
ALICATES Y CORTADORES



REDLINE VDE

PREMIUM QUALITY SAFETY PLIERS & CUTTERS

VDE / 1000V ISOLIERTE ZANGEN - PREMIUM QUALITÄT
 PINCES VDE DE QUALITÉ PREMIUM
 ALICATES Y ALICATES DE CORTE DE SEGURIDAD DE ALTA CALIDAD



1 Two component, ergonomic design, with anti-slip horns for increased comfort, control & safety

Zwei-Komponentengriffe, ergonomisches Design, mit Abgleitschutz für höheren Komfort, bessere Handhabung und Sicherheit
 Manches bicomposant de conception ergonomique avec épaulements antidérapants pour un confort accru, une meilleure maîtrise de l'outil et plus de sécurité
 Mango de diseño ergonómico de dos componentes y soportes antideslizantes para mayor comodidad, control y seguridad

2 Induction hardened jaws for outstanding long term performance

Induktionsgehärtete Schneiden für überragend langlebige Funktion
 Mâchoires trempées par induction pour une efficacité remarquable sur la durée
 Mordazas endurecidas por inducción para un excelente rendimiento duradero

3 Cutting jaws with C.K optimised geometry for unsurpassed cutting performance

Schneiden mit von C.K optimierter Geometrie für unübertroffene Schneidleistung
 Mâchoires coupantes dotées de la géométrie optimisée C.K pour un rendement de coupe imbattable
 Mordazas de corte con una geometría optimizada de C.K para conseguir un rendimiento de corte insuperable

4 Special alloy steel, drop forged, hardened & tempered for exceptional strength & durability

Legierter Spezialstahl, gesenkgeschmiedet, gehärtet und angelassen für außerordentliche Festigkeit und Langlebigkeit
 Acier allié spécial, matricé, trempé et revenu pour une résistance et une durabilité exceptionnelles
 Acero de aleación especial, forjado, endurecido y templado para una resistencia y durabilidad excepcionales

5 VDE approved - individually tested to 10,000V for safe live working up to 1,000v

VDE-zertifiziert - individuell getestet mit 10.000 V für sicheres Arbeiten bis zu 1.000 V
 Homologation VDE - outils testés individuellement à 10 000 V pour garantir une utilisation en toute sécurité sur des équipements sous tension jusqu'à 1 000 V
 VDE aprobado - testados individualmente a 10.000 V para la seguridad durante el trabajo hasta 1.000 V

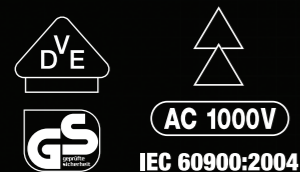

RedLine™ VDE

Conforms to IEC 60900:2004. Approved and independently audited by the German VDE institute.

Entspricht der Norm IEC 60900:2004. Zugelassen und unabhängig geprüft durch das deutsche VDE-Institut.
 Conformité à la norme CEI 60900:2004. Outils homologués et vérifiés de manière indépendante par l'institut allemand VDE.
 Cumple con la norma IEC 60900:2004. Aprobados y auditados de forma independiente por el instituto alemán VDE.

COMBICUTTER

IT STRIPS, IT BENDS, IT SHEARS

ABISOLIEREN, BIEGEN, ABSCHEREN
 DÉNUDE, CINTRE, CISAILLE
 PELA, DOBLA Y CORTA



Specially designed for electrical installation work, these award winning cutters have transformed the way in which electricians work and have become the number one choice of professionals.

Die speziell für elektrische Installationsarbeiten entwickelten und auch prämierten Seitenschneider sind inzwischen die erste Wahl bei Elektrikern.

Spécialement conçues pour les travaux d'installation électrique, ces pinces coupantes primées ont transformé la façon dont les électriciens travaillent et sont devenues le choix numéro un des professionnels.

Diseñados especialmente para trabajos de instalación eléctrica, estos galardonados alicates cortadores han transformado la forma de trabajar de los electricistas y se han convertido en la opción número uno de los profesionales.

IT STRIPS

ABISOLIEREN
 DÉNUDE
 PELA



Wire stripping notches - for effortless and damage free stripping of 1.5 and 2.5mm² wire.

Abisoliernuten - für müheloses und beschädigungsfreies Abisolieren von Drahtquerschnitten von 1,5 und 2,5 mm².

Encoches à dénuder - pour dénuder sans peine et sans dommages les fils de 1,5 et 2,5 mm²

Muecas para pelar cables sin esfuerzo y sin producir daños al pelar cables de 1,5 y 2,5 mm².

IT BENDS

BIEGEN
 CINTRE
 DOBLA



Wire bending anvil - for quick and damage free doubling back of copper wire.

Drahtbiegeamboss für schnelles und beschädigungsfreies Dublieren von Kupferdrähten.

Contre-outil de cintrage des fils - pour rabattre rapidement et sans dommages les fils de cuivre.

Yunque para doblar el cable a fin de conseguir un doblado del cable de cobre rápido y sin causar daños.

IT SHEARS

ABSCHEREN
 CISAILLE
 CORTA



Patress screw shear - for damage free cutting of patress screws.

Abscherfunktion für beschädigungsfreies Abschneiden von 3,5-mm-Steckdosenschrauben.

Cisailage des vis - pour couper sans dommages les vis de boîtes d'encastrement de 3,5 mm.

Cortatornillos incorporado para conseguir un corte sin causar daños para tornillos de 3,5 mm.

REDLINE VDE

- Patress screw shear for damage free cutting of 3.5mm patress screws



VDE combicutter1™

EN 60900, ISO 5749, VDE0682/201, ASTM-F 1505

| Item Number | Length | Wire Size | Wire Size | Wire Size | Quantity |
|-------------|----------|-----------|-----------|-----------|----------|
| 431004 | 160mm 6" | 2.0mm | 2.8mm | >4.0mm | 3 |

- Patress screw shear for damage free cutting of 3.5mm patress screws & 4mm conduit cover screws



VDE combicutter1 MAX™

EN 60900, VDE0682/201, ASTM-F 1505

| Item Number | Length | Wire Size | Wire Size | Wire Size | Quantity |
|-------------|----------|-----------|-----------|-----------|----------|
| T39071-1180 | 180mm 7" | 2.5mm | 3.0mm | >4.0mm | 3 |

- Wire stripping notches for effortless & damage free stripping of 1.5 & 2.5mm² wire
- Patress screw shear for damage free cutting of 3.5mm patress screws



VDE combicutter2™

EN 60900, ISO 5749, VDE0682/201, ASTM-F 1505

| Item Number | Length | Wire Size | Wire Size | Wire Size | Quantity |
|-------------|----------|-----------|-----------|-----------|----------|
| 431009 | 160mm 6" | 2.0mm | 2.8mm | >4.0mm | 3 |

- Wire stripping notches for effortless & damage free stripping of 1.5 & 2.5mm² wire
- Wire bending anvil for quick & damage free doubling back of copper wire
- Patress screw shear for damage free cutting of 3.5mm patress screws



VDE combicutter3™

EN 60900, ISO 5749, VDE0682/201, ASTM-F 1505

| Item Number | Length | Wire Size | Wire Size | Wire Size | Quantity |
|-------------|----------|-----------|-----------|-----------|----------|
| 431008 | 160mm 6" | 2.0mm | 2.8mm | >4.0mm | 3 |

- Wire stripping notches for effortless & damage free stripping of 1.5 & 2.5mm² wire
- Wire bending anvil for quick & damage free doubling back of copper wire
- Patress screw shear for damage free cutting of 3.5mm patress screws & 4mm conduit cover screws.



VDE combicutter3 MAX™

EN 60900, VDE0682/201, ASTM-F 1505

| Item Number | Length | Wire Size | Wire Size | Wire Size | Quantity |
|-------------|----------|-----------|-----------|-----------|----------|
| T39071-3180 | 180mm 7" | 2.5mm | 3.0mm | >4.0mm | 3 |

- Wire stripping notches for effortless & damage free stripping of 1.5 & 2.5mm² wire



VDE Side cutters - Wire stripping

EN 60900, ISO 5749, VDE0682/201, ASTM-F 1505

| Item Number | Length | Wire Size | Wire Size | Wire Size | Quantity |
|-------------|----------|-----------|-----------|-----------|----------|
| 431019 | 160mm 6" | 2.0mm | 2.8mm | >4.0mm | 3 |



VDE Side cutters - Standard

EN 60900, ISO 5749, VDE0682/201, ASTM-F 1505

| Item Number | Length | Wire Size | Wire Size | Wire Size | Quantity |
|-------------|----------|-----------|-----------|-----------|----------|
| 431017 | 160mm 6" | 2.0mm | 2.8mm | >4.0mm | 3 |
| 431005 | 180mm 7" | 2.5mm | 3.0mm | >4.0mm | 3 |

- High leverage design for increased cutting capacity



VDE Side cutters - High leverage

EN 60900, ISO 5749, VDE0682/201, ASTM-F 1505

| Item Number | Length | Wire Size | Wire Size | Wire Size | Quantity |
|-------------|-----------|-----------|-----------|-----------|----------|
| 431006 | 165mm 6½" | 2.2mm | 3.8mm | >6.0mm | 3 |
| 431007 | 200mm 8" | 2.5mm | 4.2mm | >6.0mm | 3 |

- Shearing action for clean cut results
- Razor sharp, parrot beak blades for effortless cuts
- Suitable for copper & aluminium wire only



VDE Cable cutters

EN 60900, VDE0682/201, ASTM-F 1505

| Item Number | Length | Wire Size | Quantity |
|-------------|----------|-----------|----------|
| 431030 | 160mm 6" | 16.0mm | 3 |

- Shearing action for clean cut results
- Razor sharp, parrot beak blades for effortless cuts
- Suitable for copper & aluminium wire only



VDE Cable cutters

EN 60900, VDE0682/201, ASTM-F 1505

| Item Number | Length | Wire Size | Quantity |
|-------------|-----------|-----------|----------|
| 431031 | 210mm 8¼" | 20.0mm | 3 |





VDE ELECTRICIAN'S PLIERS

1 Tapered nose - streamlined for better access, and ideal for gripping nuts and cutting wires in recessed cabinets



2 Gutter nut holder - specially profiled jaw for securely holding square nuts used on cable trays and cabinets



3 Pin holder - machined at 90° to the angled face for holding cable clips/nails upright while hammering



VDE Electrician's pliers

EN 60900, VDE0682/201, ASTM-F 1505



| Item Number | Length | Wire Size | Wire Size | Wire Size | Wire Size |
|-------------|----------|-----------|-----------|-----------|-----------|
| T39077-180 | 180mm 7" | 1.6mm | 2.5mm | >4.0mm | 3 |



- Precision engineered jaws for exceptional grip
- Extra long cutting edges for increased cutting capacity



VDE Combination pliers

EN 60900, ISO 5746, VDE0682/201, ASTM-F 1505



| Item Number | Length | Wire Size | Wire Size | Wire Size | Wire Size |
|-------------|----------|-----------|-----------|-----------|-----------|
| 431001 | 165mm 6" | 1.6mm | 2.5mm | >4.0mm | 3 |
| 431002 | 185mm 7" | 1.6mm | 2.5mm | >4.0mm | 3 |
| 431003 | 205mm 8" | 2.0mm | 2.8mm | >4.0mm | 3 |

- Serrated inside jaws for secure gripping



VDE Snipe nose pliers - Straight

EN 60900, ISO 5745, VDE0682/201, ASTM-F 1505



| Item Number | Length | Wire Size | Wire Size | Wire Size | Wire Size |
|-------------|-----------|-----------|-----------|-----------|-----------|
| 431013 | 175mm 6½" | 1.4mm | 2.0mm | >4.0mm | 3 |
| 431014 | 200mm 8" | 1.6mm | 2.0mm | >4.0mm | 3 |

- Serrated inside jaws for secure gripping
- Bent nose for special access needs



VDE Snipe nose pliers - Bent

EN 60900, ISO 5745, VDE0682/201, ASTM-F 1505



| Item Number | Length | Wire Size | Wire Size | Wire Size | Wire Size |
|-------------|----------|-----------|-----------|-----------|-----------|
| 431015 | 200mm 8" | 1.6mm | 2.5mm | >4.0mm | 3 |

- Micro adjustment for damage free repeatable results
- Spring assisted opening for convenience



VDE Wire stripping pliers

EN 60900, VDE0682/201, ASTM-F 1505



| Item Number | Length | Wire Size | Wire Size |
|-------------|----------|-------------|-----------|
| 431012 | 160mm 6" | 0.3 - 5.0mm | 3 |

CONTENTS: Combination pliers 180mm. Combicutter 160mm. Snipe nose pliers 200mm.



VDE Pliers Set - 3 Piece



| Item Number | Quantity |
|-------------|----------|
| T3805 | 1 |

REDLINE

PREMIUM QUALITY PLIERS & CUTTERS

STANDARD ZANGEN - PREMIUM QUALITÄT
PINCES DE PREMIÈRE QUALITÉ
ALICATES Y ALICATES DE CORTE DE ALTA CALIDAD



1 Two component, ergonomic design, with anti-slip horns for increased comfort, control & safety

Zwei-Komponentengriffe, ergonomisches Design, mit Abgleitschutz für höheren Komfort, bessere Handhabung und Sicherheit
Manches bicomposant de conception ergonomique avec épaulements antidérapants pour un confort accru, une meilleure maîtrise de l'outil et plus de sécurité
Diseño ergonómico con dos componentes y soportes antideslizantes para mayor comodidad, control y seguridad

2 Induction hardened jaws for outstanding long term performance

Induktionsgehärtete Schneiden für überragend langlebige Funktion
Mâchoires trempées par induction pour une efficacité remarquable sur la durée
Mordazas endurecidas por inducción para un excelente rendimiento duradero

3 Cutting jaws with C.K optimised geometry for unsurpassed cutting performance

Schneiden mit von C.K optimierter Geometrie für unübertroffene Schneidleistung
Mâchoires coupantes dotées de la géométrie optimisée C.K pour un rendement de coupe imbattable
Mordazas de corte con una geometría optimizada de C.K para conseguir un rendimiento de corte insuperable

4 Special alloy steel, drop forged, hardened & tempered for exceptional strength & durability

Legierter Spezialstahl, gesenkgeschmiedet, gehärtet und angelassen für außerordentliche Festigkeit und Langlebigkeit
Acier allié spécial, matricé, trempé et revenu pour une résistance et une durabilité exceptionnelles
Acero de aleación especial, forjado, endurecido y templado para una resistencia y durabilidad excepcionales



RedLine™

REDLINE



Side cutters - Standard

ISO 5749

| Item Number | Length | Wire Size | Wire Size | Wire Size | Wire Size | Wire Size |
|-------------|-----------|-----------|-----------|-----------|-----------|-----------|
| T3750 145 | 140mm 5½" | 1.4mm | 1.9mm | >4.0mm | 3 | |
| T3750 160 | 160mm 6" | 2.0mm | 2.8mm | >4.0mm | 3 | |
| T3750 180 | 180mm 7" | 2.5mm | 3.0mm | >4.0mm | 3 | |

- High leverage design for increased cutting capacity



Side cutters - High leverage

ISO 5749

| Item Number | Length | Wire Size | Wire Size | Wire Size | Wire Size | Wire Size |
|-------------|-----------|-----------|-----------|-----------|-----------|-----------|
| T3720 65 | 165mm 6½" | 2.2mm | 3.8mm | >6.0mm | 3 | |
| T3720 8 | 200mm 8" | 2.5mm | 4.2mm | >6.0mm | 3 | |

- Shearing action for clean cut results
- Razor sharp, parrot beak blades for effortless cuts
- Suitable for copper & aluminium wire only



Cable cutters

| Item Number | Length | Wire Size | Wire Size | Wire Size |
|-------------|-----------|-----------|-----------|-----------|
| T3964 6 | 160mm 6½" | 16.0mm | | 3 |

- Precision engineered jaws for exceptional grip
- Extra long cutting edges for increased cutting capacity



Combination pliers

ISO 5746

| Item Number | Length | Wire Size | Wire Size | Wire Size | Wire Size | Wire Size |
|-------------|----------|-----------|-----------|-----------|-----------|-----------|
| T3867 6 | 160mm 6" | 1.6mm | 2.5mm | >4.0mm | 3 | |
| T3867 7 | 180mm 7" | 1.6mm | 2.5mm | >4.0mm | 3 | |
| T3867 8 | 200mm 8" | 2.0mm | 2.8mm | >4.0mm | 3 | |

- Serrated inside jaws for secure gripping



Snipe nose pliers - Straight

ISO 5745

| Item Number | Length | Wire Size | Wire Size | Wire Size | Wire Size | Wire Size |
|-------------|-----------|-----------|-----------|-----------|-----------|-----------|
| T3909 5 | 140mm 5½" | 1.2mm | 1.6mm | >4.0mm | 3 | |
| T3909 6 | 170mm 6¾" | 1.4mm | 1.9mm | >4.0mm | 3 | |
| T3906 8 | 200mm 8" | 1.6mm | 2.0mm | >4.0mm | 3 | |

- Serrated inside jaws for secure gripping
- Bent nose for special access needs



Snipe nose pliers - Bent

ISO 5745

| Item Number | Length | Wire Size | Wire Size | Wire Size | Wire Size | Wire Size |
|-------------|----------|-----------|-----------|-----------|-----------|-----------|
| T3907 8 | 200mm 8" | 1.6mm | 2.0mm | >4.0mm | 3 | |

- Micro adjustment for damage free repeatable results
- Spring assisted opening for convenience



Wire stripping pliers

ISO 5743

| Item Number | Length | Wire Size | Quantity |
|-------------|----------|-------------|----------|
| T3754 | 160mm 6" | 0.3 - 5.0mm | 3 |

CONTENTS: Combination pliers 180mm. Side cutters 160mm. Snipe nose pliers 200mm.



Pliers set - 3 Piece

| Item Number | Quantity |
|-------------|----------|
| T3803 | 1 |

CONTENTS: Wire stripping pliers 160mm. Side cutters 160mm. Snipe nose pliers 200mm.



Pliers set - 3 Piece

| Item Number | Quantity |
|-------------|----------|
| T3804 | 1 |



CLASSIC PROFESSIONAL GENERAL PURPOSE PLIERS & CUTTERS

PROFESSIONELLE UNIVERSAL-ZANGEN
PINCES PROFESSIONNELLES A USAGE UNIVERSEL
ALICATES Y ALICATES DE CORTE DE USO GENERAL PARA PROFESIONALES

- 1 Induction hardened jaws for outstanding long term performance**
Induktionsgehärtete Schneiden für überragend langlebige Funktion
Mâchoires trempées par induction pour une efficacité remarquable sur la durée
Mordazas endurecidas por inducción para un excelente rendimiento duradero
- 2 High alloy steel, drop forged, hardened & tempered for exceptional strength & durability**
Hochlegierter Stahl, gesenkgeschmiedet, gehärtet und angelassen für außerordentliche Festigkeit und Langlebigkeit.
Acier fortement allié, matricé, trempé et revenu pour une résistance et une durabilité exceptionnelles
Acero de alta aleación, forjado, endurecido y templado para una resistencia y durabilidad excepcionales
- 3 Heads polished and lacquered for corrosion protection**
Köpfe für Korrosionsschutz poliert und lackiert
Têtes polies et laquées pour la protection contre la corrosion
Cabezales pulidos y barnizados para proteger contra la corrosión
- 4 Wipe clean PVC handles for added convenience**
PVC-Griffe können durch einfaches Abwischen sehr leicht gereinigt werden
Manches PVC faciles à nettoyer pour un plus grand confort d'utilisation
Mangos de PVC de fácil limpieza para mayor comodidad



Classic™

CLASSIC



Side cutters - Standard

ISO 5749

| Item Number | Length | Jaw Width | Tip Width | Tip Length | Quantity |
|-------------|-----------|-----------|-----------|------------|----------|
| T3623B 5 | 140mm 5½" | 1.2mm | 1.6mm | >4.0mm | 6 |
| T3623B 6 | 160mm 6" | 1.6mm | 2.1mm | >4.0mm | 6 |

- High leverage design for increased cutting capacity



Side cutters - High leverage

ISO 5749

| Item Number | Length | Jaw Width | Tip Width | Tip Length | Quantity |
|-------------|----------|-----------|-----------|------------|----------|
| T3627B 7 | 180mm 7" | 2.2mm | 3.8mm | >6.0mm | 6 |

- Precision engineered jaws for exceptional grip
- Extra long cutting edges for increased cutting capacity



Combination pliers

ISO 5746

| Item Number | Length | Jaw Width | Tip Width | Tip Length | Quantity |
|-------------|----------|-----------|-----------|------------|----------|
| T3621B 6 | 160mm 6" | 1.6mm | 2.5mm | >4.0mm | 6 |
| T3621B 7 | 180mm 7" | 1.6mm | 2.5mm | >4.0mm | 6 |
| T3621B 8 | 200mm 8" | 2.0mm | 2.8mm | >4.0mm | 6 |

- Serrated inside jaws for secure gripping



Snipe nose pliers - Straight

ISO 5745

| Item Number | Length | Jaw Width | Tip Width | Tip Length | Quantity |
|-------------|-----------|-----------|-----------|------------|----------|
| T3622B | 140mm 5½" | 1.4mm | 1.9mm | >4.0mm | 6 |
| T3626B 8 | 200mm 8" | 1.6mm | 2.0mm | >4.0mm | 6 |

WATERPUMP PLIERS

- Special alloy steel, drop forged, hardened & tempered for exceptional strength & durability
- Induction hardened jaws for outstanding long term performance
- 'Slide to adjust' mechanism for fast & accurate size adjustment
- Slim head & jaws for access to confined spaces
- Contoured anti-slip handles for comfortable & powerful operation



Waterpump pliers - Speedlok

DIN ISO 8976

| Item Number | Length | Jaw Width | Quantity |
|-------------|-----------|-----------|----------|
| T3655 250 | 250mm 10" | 38mm 1½" | 6 |
| T3655 300 | 300mm 12" | 55mm 2" | 6 |

- Special alloy steel, drop forged, hardened & tempered for exceptional strength & durability
- Induction hardened jaws for outstanding long term performance
- Box joint design with double pivot support for strength
- Slim head & jaws for access to confined spaces
- Contoured anti-slip handles for comfortable & powerful operation



Waterpump pliers - Heavy duty

DIN 8976

| Item Number | Length | Jaw Width | Quantity |
|-------------|-----------|-----------|----------|
| T3659A 175 | 180mm 7" | 25mm 1" | 3 |
| T3659A 240 | 240mm 9½" | 32mm 1¼" | 3 |
| T3659A 300 | 300mm 12" | 45mm 1¾" | 3 |
| T3659A 400 | 400mm 16" | 64mm 2½" | 1 |



Waterpump pliers - Standard

DIN ISO 8976

| Item Number | Length | Jaw Width | Quantity |
|-------------|-----------|-----------|----------|
| T3651 09 | 250mm 10" | 38mm 1½" | 3 |

- Special alloy steel, drop forged, hardened & tempered for exceptional strength & durability
- Induction hardened jaws for outstanding long term performance
- Self adjusting jaws for optimised grip & pressure
- Push button adjustment for convenient size setting
- Contoured anti-slip handles for comfortable & powerful operation



Pliers wrench

| Item Number | Length | Wrench Size | Wrench Width | Wrench Depth | Quantity |
|-------------|-----------|-------------|--------------|--------------|----------|
| T3656 250 | 250mm 10" | 20mm | 36mm / M24 | 53mm | 3 |



RATCHET CRIMPING PLIERS

RATSCHEN-CRIMPZANGEN

PINCES À SERTIR À CLIQUET

ALICATES PARA ENGASTAR CON TRINQUETE



1 Auto-stop ratchet system releases when correct pressure is applied to ensure precise crimping

Ratschensystem mit automatischer Schnellauflösung, die beim Erreichen des korrekten Andrucks die Zange wieder freigibt, um präzises Crimpen zu gewährleisten

Le système de cliquet à arrêt automatique débraye dès que la pression correcte est appliquée afin d'assurer un sertissage précis

El sistema de parada automática del trinquete se activa cuando se aplica la presión adecuada para garantizar un engaste preciso

2 Precision engineered dies for quality crimps and safe connections

Präzise bearbeitete Quetschbacken für qualitatives Crimpen und sichere Verbindungen

Matrices à usinage de précision pour des sertissages de qualité et des connexions sûres

Matrices con ingeniería de precisión para conseguir engastes de calidad y conexiones seguras

3 Dies manufactured from fully hardened carbon alloy steel for strength & durability

Aus voll gehärtetem, legiertem Kohlenstoffstahl für Festigkeit und Langlebigkeit

Matrices en acier allié au carbone entièrement trempé, garantissant résistance et durabilité

Matrices fabricadas en acero de aleación al carbono totalmente endurecido para mayor resistencia y durabilidad

4 Heavy duty construction, tested up to 40,000 cycles, guaranteed for 30,000 crimps per tool

Sehr robust, bis zu 40.000 Anwendungen getestet, 30.000 Vorgänge werden garantiert

Construction robuste, testée jusqu'à 40 000 cycles, garantie pour 30 000 sertissages par outil

Construcción resistente, testada con 40.000 ciclos, garantizando 30.000 remaches por herramienta

5 Ergonomic design for increased comfort & control

Ergonomisches Design für erhöhten Komfort und bessere Bedienung

Conception ergonomique pour un confort accru et une meilleure maîtrise de l'outil

Diseño ergonómico para mayor comodidad y control



CRIMPING PLIERS

- Designed for the safe & secure crimping of boot lace ferrules



Ratchet crimping pliers - Small ferrules

| Item Number | Icon | Length | mm ² /AWG | Box |
|-------------|------|--------|----------------------|-----|
| 430018 | | 190mm | 0.14 - 2.5 / 26 - 14 | 3 |

- Designed for the safe & secure crimping of boot lace ferrules



Ratchet crimping pliers - Medium ferrules

| Item Number | Icon | Length | mm ² /AWG | Box |
|-------------|------|--------|----------------------|-----|
| 430029 | | 190mm | 0.25 - 6.0 / 20 - 10 | 3 |

- Designed for the safe & secure crimping of boot lace ferrules



Ratchet crimping pliers - Large ferrules

| Item Number | Icon | Length | mm ² /AWG | Box |
|-------------|------|--------|----------------------|-----|
| 430022 | | 230mm | 10 - 25 / 8 - 3 | 3 |

- Designed for the safe & secure crimping of bell mouth ferrules



Ratchet crimping pliers - Non-insulated terminals

| Item Number | Icon | Length | mm ² /AWG | Box |
|-------------|------|--------|----------------------|-----|
| T3676 | | 350mm | 6 - 25 / 10 - 4 | 3 |

- Designed for the safe & secure crimping of red, blue or yellow insulated terminals



Ratchet crimping pliers - Insulated terminals

| Item Number | Icon | Length | mm ² /AWG | Box |
|-------------|------|--------|----------------------|-----|
| 430021 | | 220mm | 0.5 - 6.0 / 20 - 10 | 3 |

- Designed for the safe & secure crimping of non insulated terminals



Ratchet crimping pliers - Non-insulated terminals

| Item Number | Icon | Length | mm ² /AWG | Box |
|-------------|------|--------|----------------------|-----|
| 430025 | | 230mm | 1.5 - 10 / 16 - 8 | 3 |

- Designed for the safe & secure crimping of BNC/TNC connectors to coaxial cable



Ratchet crimping pliers - Coax, BNC, TNC

| Item Number | Length | Info | Box |
|-------------|--------|---|-----|
| 430026 | 230mm | For: 58, 59, 62, 8X, 140, 141, 174, 210, 223, 303, 400. | 3 |

- Designed for the safe & secure attachment of modular plugs without die changes
- Built in wire stripper/cutter mechanism for convenience.



Ratchet crimping pliers - Modular plugs 1

| Item Number | Length | Info | Box |
|-------------|--------|---|-----|
| 430020 | 220mm | 4P2C, 4P4C, 6P4C (RJ11), 6P6C (RJ12), 8P8C (RJ45) and 6P6C/Offset | 3 |

- Designed for the safe & secure attachment of modular plugs without die changes
- Built in wire stripper/cutter mechanism for convenience



Ratchet crimping pliers - Modular plugs 2

| Item Number | Length | Info | Box |
|-------------|--------|--|-----|
| 430028 | 250mm | 8P8C (RJ-45) 6P6C (RJ-12) and 6P4C (RJ-11) | 3 |

- Designed for the safe & secure crimping of boot lace ferrules
- Hardened & tempered high alloy carbon steel for increased strength & durability
- Matt chrome plated for corrosion protection
- Contoured grips with anti-slip horns for comfort & safety



Crimping plier - Small ferrules

| Item Number | Length | mm ² /AWG | Box |
|-------------|--------|----------------------|-----|
| 430005 | 145mm | 0.25 - 2.5 / 23 - 13 | 3 |

- Designed for the safe & secure crimping of boot lace ferrules
- Hardened & tempered high alloy carbon steel for increased strength & durability
- Matt chrome plated for corrosion protection
- Contoured grips with anti-slip horns for comfort & safety



Crimping plier - Medium ferrules

| Item Number | Length | mm ² /AWG | Box |
|-------------|--------|----------------------|-----|
| 430006 | 220mm | 0.5 - 16 / 20 - 5 | 3 |

CIRCLIP PLIERS

- Chequered handles for grip



Circlip pliers - Inside straight

| Item Number | Length | Ø | DIN | Box |
|-------------|-----------|------------|-----|-----|
| T3710 0 | 140mm 5½" | 8 - 13mm | J0 | 5 |
| T3710 5 | 140mm 5½" | 12 - 25mm | J1 | 5 |
| T3710 7 | 180mm 7" | 19 - 60mm | J2 | 5 |
| T3710 8 | 220mm 8¾" | 40 - 100mm | J3 | 5 |
| T3710 11 | 300mm 12" | 85 - 140mm | J4 | 5 |

- Chequered handles for grip



Circlip pliers - Outside straight

| Item Number | Length | Ø | DIN | Box |
|-------------|-----------|------------|-----|-----|
| T3711 0 | 140mm 5½" | 3 - 10mm | A0 | 5 |
| T3711 5 | 140mm 5½" | 10 - 25mm | A1 | 5 |
| T3711 7 | 180mm 7" | 19 - 60mm | A2 | 5 |
| T3711 8 | 220mm 8¾" | 40 - 100mm | A3 | 5 |
| T3711 11 | 300mm 12" | 85 - 140mm | A4 | 5 |

- Chequered handles for grip



Circlip pliers - Inside bent

| Item Number | Length | Ø | DIN | Box |
|-------------|-----------|------------|-----|-----|
| T3712 5 | 140mm 5½" | 12 - 25mm | J11 | 5 |
| T3712 7 | 180mm 7" | 19 - 60mm | J21 | 5 |
| T3712 8 | 220mm 8¾" | 40 - 100mm | J31 | 5 |

- Chequered handles for grip



Circlip pliers - Outside bent

| Item Number | Length | Ø | DIN | Box |
|-------------|-----------|------------|-----|-----|
| T3713 0 | 140mm 5½" | 3 - 10mm | A01 | 5 |
| T3713 5 | 140mm 5½" | 10 - 25mm | A11 | 5 |
| T3713 7 | 180mm 7" | 19 - 60mm | A21 | 5 |
| T3713 8 | 220mm 8¾" | 40 - 100mm | A31 | 5 |

- Push button changeover from inside to outside configuration for convenience

CONTENTS: 1 x adjustable circlip pliers. 1 x inside circlips, sizes: 12, 14, 16, 18, 20 & 22mm. 1 x outside circlips, sizes: 12, 14, 16, 18, 20 & 22mm.



Circlip pliers set - Adjustable

| Item Number | Box |
|-------------|-----|
| T3716 | 3 |

RIVETING PLIERS & RIVETS

- Heavy duty steel construction for exceptional strength & durability
- Colour coded interchangeable nose bushes for convenience (Nose spanner included)
- 3 jaw mechanism for increased grip and outstanding long term performance – 50% greater gripping strength than a standard 2 jaw riveter
- Ergonomic anti-slip handles for increased comfort



Riveting pliers

| Item Number | Length | Interchangeable nose bushes for setting | Quantity |
|-------------|---------------|--|----------|
| T3820 | 260mm 10 1/2" | 3.15mm (1/8"), 4mm (5/32"), 4.8mm (3/16") rivets | 3 |

CONTENTS: Riveting pliers. 25 x aluminium rivets, sizes: 1/8" (3.2mm), 5/32" (4.0mm) & 3/16" (4.8mm).



Riveting pliers set

| Item Number | Quantity |
|-------------|----------|
| T3820AS | 1 |

- Heavy duty steel construction for exceptional strength & durability
- 'Anti shock' design protects from injuries to wrist, arm or shoulder
- Cushion grip handle for superior grip & comfort
- Colour coded interchangeable nose bushes for convenience

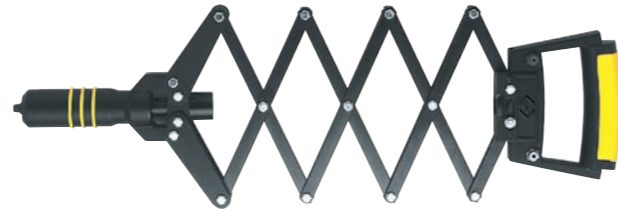

Lazy tong riveter

| Item Number | Length | Interchangeable nose bushes for setting | Quantity |
|-------------|---------------------------|---|----------|
| T3822A | 305 - 780mm 12' - 32 1/2" | 2.4mm (3/32"), 3.15mm (1/8"), 4mm (5/32"), 4.8mm (3/16"), 6mm (1/4") rivets | 1 |

- Colour coded for simple size identification



Rivets - Aluminium (Pack 50)

| Item Number | Length | Interchangeable nose bushes for setting | Quantity |
|-------------|------------------------|---|----------|
| T3819A 408 | 3.15 x 6mm 1/8 x 1/4" | short | 15 |
| T3819A 412 | 3.15 x 9mm 1/8 x 3/8" | medium | 15 |
| T3819A 415 | 3.15 x 12mm 1/8 x 1/2" | large | 15 |
| T3819A 508 | 4 x 6mm 5/32 x 1/4" | short | 15 |
| T3819A 512 | 4 x 9mm 5/32 x 3/8" | medium | 15 |
| T3819A 515 | 4 x 12mm 5/32 x 1/2" | large | 15 |
| T3819A 612 | 4.8 x 9mm 3/16 x 3/8" | medium | 15 |
| T3819A 615 | 4.8 x 12mm 3/16 x 1/2" | long | 15 |
| T3819A 620 | 4.8 x 16mm 3/16 x 5/8" | ex long | 15 |

- Galvanised steel for corrosion resistance



Washers - (Pack 100)

| Item Number | Length | Quantity |
|-------------|-------------|----------|
| T3824 12 | 3.15mm 1/8" | 15 |
| T3824 15 | 4mm 5/32" | 15 |
| T3824 18 | 4.8mm 3/16" | 15 |

CONTENTS: 3 x riveting pliers. 3 x riveting pliers sets. 6 x boxes of aluminium rivets (x9 sizes). 6 x boxes of washers (x3 sizes).



Riveting display stand

| Item Number | Dimensions | Quantity |
|-------------|-------------------|----------|
| T3825LS | 570 x 530 x 330mm | 1 |

PVC CUTTERS

- Heavy duty aluminium body - Strong & light
- Ratchet action razor sharp stainless steel blade for effortless cutting of; PVC conduit, blue water mains, plastic pipe, rubber hose, pneumatic pipe, electrical sleeving, etc
- Complete with special adaptor for straight or mitre cutting of small rectangular cross-section trunking



PVC pipe & conduit cutter - Ratchet

| Item Number | Length | Blade Width | Quantity |
|-------------|--------|-------------|----------|
| 430003 | 220mm | 32mm | 3 |

- Glass fibre reinforced polycarbonate body - Strong & light
- Razor sharp stainless steel blade for efficient cutting of: PVC conduit, blue water mains, plastic pipe, rubber hose, pneumatic pipe, electrical sleeving, etc



PVC pipe & conduit cutter

| Item Number | Length | Blade Width | Quantity |
|-------------|--------|-------------|----------|
| 430001 | 195mm | 28mm | 3 |

- Heavy duty aluminium body - Strong & light
- Lever action razor sharp stainless steel blade for effortless cutting of; PVC conduit, blue water mains, plastic pipe, rubber hose, pneumatic pipe, electrical sleeving, wooden dowel, etc
- 5 interchangeable anvils (flat, double radius, single radius, 90° square and mitre) allow a variety of cross sections to be cut, both straight and mitred



Multi cutter set

| Item Number | Quantity |
|-------------|----------|
| T2240 | 3 |

PINCERS & TOP CUTTERS

- Optimised jaw design for effective gripping & extracting of screws, nails, fixings, etc
- Specially profiled cutting blades for cutting metal rod & wire
- High alloy steel, drop forged, hardened & tempered for exceptional strength & durability
- Wipe clean PVC handles for added convenience
- Black lacquered for corrosion protection



Pincers

DIN/ISO 9243

| Item Number | Length | Opening | Capacity | Quantity |
|-------------|----------|---------|----------|----------|
| T4108A 06 | 160mm 6" | 2.0mm | >4.0mm | 3 |
| T4108A 07 | 180mm 7" | 2.0mm | >4.0mm | 3 |
| T4108A 08 | 200mm 8" | 2.0mm | >4.0mm | 3 |

- Heavy duty construction, drop forged alloy steel, hardened & tempered for exceptional strength & durability
- Induction hardened jaws for outstanding long term performance
- Wipe clean PVC handles for added convenience
- Black lacquered for corrosion protection

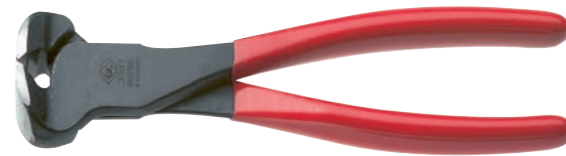

Top cutter - Heavy duty

DIN/ISO 5748

| Item Number | Length | Opening | Capacity | Quantity | |
|-------------|----------|---------|----------|----------|---|
| T3987A 7 | 180mm 7" | 2.5mm | 3.2mm | >4.0mm | 3 |

- High alloy steel, drop forged, hardened & tempered for strength & durability
- Induction hardened jaws for outstanding long term cutting performance
- Wipe clean PVC handles for added convenience
- Black lacquered for corrosion protection



Top cutter - Standard

DIN/ISO 5748

| Item Number | Length | Opening | Capacity | Quantity | |
|-------------|----------|---------|----------|----------|---|
| T3988 180 | 180mm 7" | 2.5mm | 3.2mm | >4.0mm | 3 |
| T3988 200 | 200mm 8" | 2.8mm | 3.5mm | >4.0mm | 3 |

- Special slimline design for binding & twisting wire.
- Induction hardened jaws for outstanding long term cutting performance
- High alloy steel, drop forged, hardened & tempered for exceptional strength & durability
- Wipe clean PVC handles for added convenience
- Black lacquered for corrosion protection



Top cutters - Steel fixers

DIN/ISO 9243

| Item Number | Length | Opening | Quantity |
|-------------|-----------|---------|----------|
| T4112A 08 | 220mm 8½" | 2.0mm | 3 |
| T4112A 10 | 250mm 10" | 2.0mm | 3 |
| T4112A 11 | 280mm 11" | 2.0mm | 3 |

HEAVY DUTY CUTTERS

- High tensile, special alloy jaws heat treated for cutting hard materials up to 40HRC
- Compound action mechanism applies extreme cutting forces



Bolt cutters

| Item Number | Length | 785Nmm ² (61TONS SQ ²) | 1226Nmm ² (80TONS SQ ²) | Quantity |
|-------------|-----------|---|--|----------|
| T4358 12 | 340mm 13" | 6mm | 5mm | 1 |
| T4358 15 | 400mm 16" | 7mm | 6mm | 1 |
| T4358 18 | 450mm 18" | 10mm | 7mm | 1 |
| T4358 25 | 610mm 24" | 11mm | 9mm | 1 |
| T4358 30 | 800mm 31" | 13mm | 11mm | 1 |
| T4358 36 | 900mm 35" | 15mm | 13mm | 1 |

- Compact cutters ideal for fencing, meshes and low tensile wire
- Hot drop forged chrome vanadium steel jaws with induction hardened cutting edges for strength and durability
- Compound action mechanism applies extreme cutting forces



Bolt cutter - Pocket

| Item Number | Length | 785Nmm ² (61TONS SQ ²) | 1226Nmm ² (80TONS SQ ²) | Quantity |
|-------------|-----------|---|--|----------|
| T4371A | 250mm 10" | 5mm | 3mm | 2 |

- Heavy duty construction, drop forged alloy steel, hardened & tempered for exceptional strength & durability
- Induction hardened specially profiled shearing blades for clean cutting of a wide range of wire & cables including: bowden cable, steel wire, fencing wire, stranded wire rope, copper & aluminium cables, steel rods, etc
- PVC coated handles for comfort and grip



Cable & wire rope cutter

| Item Number | Length | Opening | Quantity | |
|-------------|--------|---------|----------|---|
| T3744 | 190mm | 6mm | 4mm | 3 |

- Heavy duty construction, drop forged alloy steel, hardened & tempered for exceptional strength & durability
- Induction hardened jaws for outstanding long term performance
- Wipe clean PVC handles for added convenience
- Black lacquered for corrosion protection



Wire cutters - Heavy duty

| Item Number | Length | Opening | Quantity |
|-------------|-----------|---------|----------|
| T3961A 08 | 200mm 8" | 2.0mm | 3 |
| T3961A 10 | 250mm 10" | 3.0mm | 5 |

- Specially hardened steel punches and brass anvil for long term cutting performance
- 6 punch revolving head marked with size for convenience
- Black lacquered coating for corrosion protection
- Suitable for leather, plastic, card, etc



Revolving punch pliers

| Item Number | Length | Opening | Quantity |
|-------------|-----------|--------------------------|----------|
| T3817 | 220mm 8½" | 2, 2.5, 3, 3.5, 4, 4.5mm | 5 |

SCREWDRIVERS

SCHRAUBENDREHER
TOURNEVIS
DESTORNILLADORES



DEXTRO VDE

DEXTRO VDE
DEXTRO VDE
DEXTRO VDE

30-33

DEXTRO

DEXTRO
DEXTRO
DEXTRO

34-37

HD CLASSIC

HD CLASSIC
HD CLASSIC
HD CLASSIC

38-41

TRITON XLS

TRITON XLS
TRITON XLS
TRITON XLS

42-45

MAINSTESTERS

SPANNUNGSPRÜFER
TESTEURS DE TENSION
TESTERS

46

RATCHET SCREWDRIVERS

RATSCHEN-SCHRAUBENDREHER
TOURNEVIS À CLIQUET
DESTORNILLADORES CON TRINQUETE

46-47

IMPACT DRIVER & BITS

SCHLAGSHRAUBER & BITS
TOURNEVIS À IMPACT & EMBOUTS
TROQUEL DE IMPACTO Y BROCAS

47

BRADAWLS

DORNEN
ALÈNES
PUNTAS

47



DEXTRO VDE

PREMIUM QUALITY SAFETY SCREWDRIVERS

PREMIUMQUALITÄT - SICHERHEITSSCHRAUBENDREHER
TOURNEVIS VDE DE QUALITÉ PREMIUM
DESTORNILLADORES DE SEGURIDAD DE ALTA CALIDAD



1 Tip type marking for easy identification

Kopf Markierung für einfache Erkennung
Marquage du type de pointe pour une identification aisée
Tope superior marcado con el tipo de punta para facilitar su identificación

2 Ergonomically shaped, dual component handle for increased comfort, control & safety

Ergonomisch geformt, Zwei-Komponenten Griff für höheren Komfort, bessere Handhabung und Sicherheit
Manche ergonomique à double composant pour un confort accru, une meilleure maîtrise de l'outil et plus de sécurité
Mango de dos componentes con forma ergonómica para una mayor comodidad, control y seguridad

3 Long fine neck for precise fingertip control

Langer Hals für präzise Führung mit der Fingerspitze
Corps allongé et fin pour une meilleure maniabilité
Cuello largo y fino para un control más preciso de los dedos

4 Ridges along the head give extra grip in that last 1/4 turn

Kanten entlang dem Kopf bieten zusätzliche Griffigkeit in der letzten 1/4-Umdrehung
Les arêtes le long de la tête apportent le surplus de préhension nécessaire pour le dernier quart de tour
Puntas con superficie estructurada que proporcionan un mayor agarre en el último 1/4 de apriete

5 Handle injection moulded directly to blade giving the ultimate bond for increased reliability & durability

Direkter Spritzguss des Handgriffs mit dem Schaft ergibt absolute Verbindung für erhöhte Zuverlässigkeit und Dauerhaftigkeit
Manche moulé par injection directement sur la lame, gage de la meilleure des adhérences pour une fiabilité et une durabilité accrues
Mango de inyección moldeado directamente en la varilla proporcionando el refuerzo fundamental para una mayor fiabilidad y durabilidad

6 VDE approved - individually tested to 10,000v for safe live working up to 1,000v

VDE-Zulassung - individuell getestet mit 10.000v für sicheres Arbeiten bis zu 1.000v
Homologation VDE - outils testés individuellement à 10.000v pour garantir une utilisation en toute sécurité sur des équipements sous tension jusqu'à 1.000v
VDE aprobado - testados individualmente a 10.000v para la seguridad durante el trabajo hasta 1.000v

7 GRIP-TIP™ anti cam-out ribs reduce the risk of slipping

GRIP-TIP™ Abgleitschutzrippen reduzieren das Risiko des Abrutschens
Les nervures anti-rejet GRIP-TIP™ réduisent le risque de dérapage de l'outil
GRIP-TIP™ bordes anticaída para reducir el riesgo de deslizamiento

8 Premium quality chrome vanadium steel blade for exceptional strength & durability

Hochqualitativer Chrom-Vanadiumstahlschaft für außergewöhnliche Festigkeit und Dauerhaftigkeit
Lame en acier au chrome-vanadium de première qualité pour une résistance et une durabilité exceptionnelles
Cuchilla de acero al cromo vanadio de alta calidad para una resistencia y durabilidad excepcionales

9 Precision machined tip for an exact screw fit & damage free screwdriving

Präzise bearbeitete Spitze für exakte Anpassungen an die Schrauben und beschädigungsfreies Eindrehen
Pointe à usinage de précision pour un logement exact dans la tête de vis et un vissage sans dommages
Punta mecanizada de precisión para el ajuste exacto del tornillo y sin causar daños al atornillar

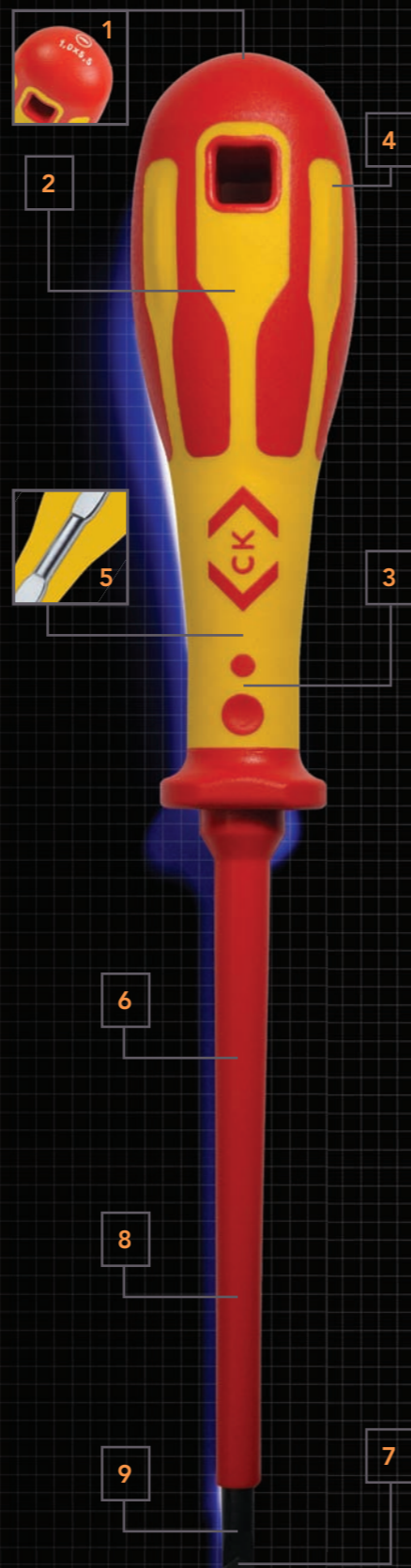

Conforms to IEC 60900:2004. Approved and independently audited by the German VDE institute.

Entspricht der Norm IEC 60900:2004. Zugelassen und unabhängig geprüft durch das deutsche VDE-Institut.
Conformité à la norme CEI 60900:2004. Outils homologués et vérifiés de manière indépendante par l'institut allemand VDE.
Cumple con la norma IEC 60900:2004. Aprobados y auditados de forma independiente por el instituto alemán VDE.

featuring GRIP-TIP™ technology

DEXTRO VDE



VDE Screwdrivers - Slotted parallel

VDE0682/201, ASTM-F 1505, EN 60900, ISO 2380-2, DIN 5264

| Item Number | + | Ø | → | ← | ⊞ |
|-------------|---------------|----------|--------------|--------------|---|
| T49144-025 | 2.5mm 3/32" | 75mm 3" | 0.4mm 0.016" | 95mm 3 3/4" | 6 |
| T49144-030 | 3.0mm 1/8" | 100mm 4" | 0.5mm 0.020" | 95mm 3 3/4" | 6 |
| T49144-035 | 3.5mm 9/64" | 100mm 4" | 0.6mm 0.024" | 95mm 3 3/4" | 6 |
| T49144-040 | 4.0mm 1/2" | 100mm 4" | 0.8mm 0.031" | 107mm 4 1/2" | 6 |
| T49144-055 | 5.5mm 7/32" | 125mm 5" | 1.0mm 0.039" | 120mm 4 3/4" | 6 |
| T49144-065 | 6.5mm 1/4" | 150mm 6" | 1.2mm 0.047" | 120mm 4 3/4" | 6 |
| T49144-080 | 8.0mm 5/16" | 175mm 7" | 1.2mm 0.047" | 135mm 5 1/8" | 6 |
| T49144-100 | 10.0mm 25/64" | 200mm 8" | 1.6mm 0.063" | 135mm 5 1/8" | 6 |



VDE Screwdrivers - PZ

VDE0682/201, ASTM-F 1505, EN 60900, ISO 8764

| Item Number | + | Ø | → | ← | ⊞ |
|-------------|-----|--------------|-------------|--------------|---|
| T49143-0 | PZ0 | 3.5mm 9/64" | 60mm 2 3/8" | 95mm 3 3/4" | 6 |
| T49143-1 | PZ1 | 5.0mm 3/16" | 80mm 3 1/8" | 107mm 4 1/2" | 6 |
| T49143-2 | PZ2 | 6.0mm 15/64" | 100mm 4" | 107mm 4 1/2" | 6 |
| T49143-2200 | PZ2 | 6.0mm 15/64" | 200mm 8" | 120mm 4 3/4" | 6 |
| T49143-3 | PZ3 | 8.0mm 5/16" | 150mm 6" | 135mm 5 1/8" | 6 |



VDE Screwdrivers - PH

VDE0682/201, ASTM-F 1505, EN 60900, ISO 8764

| Item Number | + | Ø | → | ← | ⊞ |
|-------------|-----|--------------|-------------|--------------|---|
| T49142-0 | PH0 | 3.5mm 9/64" | 60mm 2 3/8" | 95mm 3 3/4" | 6 |
| T49142-1 | PH1 | 5.0mm 3/16" | 80mm 3 1/8" | 107mm 4 1/2" | 6 |
| T49142-2 | PH2 | 6.0mm 15/64" | 100mm 4" | 120mm 4 3/4" | 6 |
| T49142-3 | PH3 | 8.0mm 5/16" | 150mm 6" | 135mm 5 1/8" | 6 |



VDE Screwdriver - Modulo

VDE0682/201, ASTM-F 1505, EN 60900

| Item Number | + | Ø | → | ← | ⊞ |
|-------------|---|--------------|-------------|--------------|---|
| T49145-1 | 1 | 5.0mm 3/16" | 80mm 3 1/8" | 107mm 4 1/2" | 6 |
| T49145-2 | 2 | 6.0mm 15/64" | 100mm 4" | 120mm 4 3/4" | 6 |

CONTENTS: 1 x modulo, sizes: 1 x 80 & 2 x 100mm.



VDE Screwdriver set - Modulo

VDE0682/201, ASTM-F 1505, EN 60900

| Item Number | + | ⊞ |
|-------------|-------|---|
| T49146 | 1 & 2 | 1 |

CONTENTS: 1 x slotted parallel, sizes: 2.5 x 75, 4.0 x 100 & 5.5 x 125mm. 1 x PZ, sizes: 1 x 80 & 2 x 100mm. Mainstester.



VDE Screwdriver set - 6 Piece SL/PZ

VDE0682/201, ASTM-F 1505, EN 60900



| Item Number | |
|-------------|---|
| T49183 | 1 |

CONTENTS: 1 x slotted parallel, sizes: 2.5 x 75, 4 x 100 & 5.5 x 125mm. 1 x PH, sizes: 1 x 80 & 2 x 100mm. Mainstester.



VDE Screwdriver set - 6 Piece SL/PH

VDE0682/201, ASTM-F 1505, EN 60900



| Item Number | |
|-------------|---|
| T49182 | 1 |

CONTENTS: 1 x slotted parallel, sizes: 2.5 x 75, 4.0 x 100, 5.5 x 125 & 6.5 x 150mm. 1 x PZ, sizes: 0 x 60, 1 x 80 & 2 x 100mm. Mainstester.



VDE Screwdriver set - 8 Piece SL/PZ

VDE0682/201, ASTM-F 1505, EN 60900



| Item Number | |
|-------------|---|
| T49193 | 1 |

CONTENTS: 1 x slotted parallel, sizes: 2.5 x 75, 4 x 100, 5.5 x 125 & 6.5 x 150mm. 1 x PH, sizes: 0 x 60, 1 x 80 & 2 x 100mm. Mainstester.



VDE Screwdriver set - 8 Piece SL/PH

VDE0682/201, ASTM-F 1505, EN 60900



| Item Number | |
|-------------|---|
| T49192 | 1 |

CONTENTS: 6 x slotted parallel, sizes: 2.5 x 75, 3 x 100, 4 x 100, 5.5 x 125 & 6.5 x 150mm. 6 x PZ, sizes: 0 x 60, 1 x 80, 2 x 100 & 2 x 200mm. 6 x PH, sizes: 1 x 80 & 2 x 100mm.



Top sellers display

| Item Number | | |
|--------------|-----------------------|---|
| DEXTROVDE-TS | stock, shelf & header | 1 |

- Optional countertop Z-frame available



Countertop Z-frame

| Item Number | |
|-------------|---|
| M0162 | 1 |

CONTENTS: 12 x slotted parallel, sizes: 2.5 x 75, 3.0 x 100 & 4.0 x 100mm. 6 x slotted parallel, sizes: 3.5 x 100, 5.5 x 125, 6.5 x 150, 8.0 x 175 & 10.0 x 200mm.



Full range display - Shelf 1

| Item Number | | |
|--------------|-----------------------|---|
| DEXTROVDE-S1 | stock, shelf & header | 1 |

CONTENTS: 6 x PZ, sizes: 0 x 60, 1 x 80, 2 x 100, 2 x 200 & 3 x 150mm. 6 x PH, sizes: 0 x 60, 1 x 80, 2 x 100 & 3 x 150mm. 6 x modulo, sizes: 1 x 75 & 2 x 100mm.

Shelf 2

| Item Number | | |
|--------------|-----------------------|---|
| DEXTROVDE-S2 | stock, shelf & header | 1 |

DEXTRO PREMIUM QUALITY SCREWDRIVERS

PREMIUMQUALITÄT - SCHRAUBENDREHER
TOURNEVIS DE QUALITÉ PREMIUM
DESTORNILLADORES DE ALTA CALIDAD



1 Tip type marking for easy identification

Kopf Markierung für einfache Erkennung
Marquage du type de pointe pour une identification aisée
Tope superior marcado con el tipo de punta para facilitar su identificación

2 Ergonomically shaped, dual component handle for increased comfort, control & safety

Ergonomisch geformt, Zwei-Komponenten Griff für höheren Komfort, bessere Handhabung und Sicherheit
Manche ergonomique à double composant pour un confort accru, une meilleure maîtrise de l'outil et plus de sécurité
Doble mango con forma ergonómica para una mayor comodidad, control y seguridad

3 Long fine neck for precise fingertip control

Langer Hals für präzise Führung mit der Fingerspitze
Corps allongé et fin pour une meilleure maniabilité
Cuello largo y fino para un control más preciso de los dedos

4 Ridges along the head give extra grip in that last 1/4 turn

Kanten entlang dem Kopf bieten zusätzliche Griffigkeit in der letzten 1/4-Umdrehung
Les arêtes le long de la tête apportent le surplus de préhension nécessaire pour le dernier quart de tour
Puntas con superficie estructurada que proporcionan un mayor agarre en el último 1/4 de apriete

5 Handle injection moulded directly to blade giving the ultimate bond for increased reliability & durability

Direkter Spritzguss des Handgriffs mit dem Schaft ergibt absolute Verbindung für erhöhte Zuverlässigkeit und Dauerhaftigkeit
Manche moulé par injection directement sur la lame, gage de la meilleure des adhérences pour une fiabilité et une durabilité accrues
Mango de inyección moldeado directamente en la varilla proporcionando el refuerzo fundamental para una mayor fiabilidad y durabilidad

6 GRIP-TIP™ anti cam-out ribs reduce the risk of slipping

GRIP-TIP™ Abgleitschutzrippen reduzieren das Risiko des Abrutschens
Les nervures anti-rejet GRIP-TIP™ réduisent le risque de dérapage de l'outil
GRIP-TIP™ bordes anticaída para reducir el riesgo de deslizamiento

7 Premium quality chrome vanadium steel blade for exceptional strength & durability

Hochqualitativer Chrom-Vanadiumstahlschaft für außergewöhnliche Festigkeit und Dauerhaftigkeit
Lame en acier au chrome-vanadium de première qualité pour une résistance et une durabilité exceptionnelles
Cuchilla de acero al cromo vanadio de alta calidad para una resistencia y durabilidad excepcionales

8 Precision machined tip for an exact screw fit & damage free screwdriving

Präzise bearbeitete Spitze für exakte Anpassungen an die Schrauben und beschädigungsfreies Eindrehen
Pointe à usinage de précision pour un logement exact dans la tête de vis et un vissage sans dommages
Punta mecanizada de precisión para el ajuste exacto del tornillo y sin causar daños al atornillar

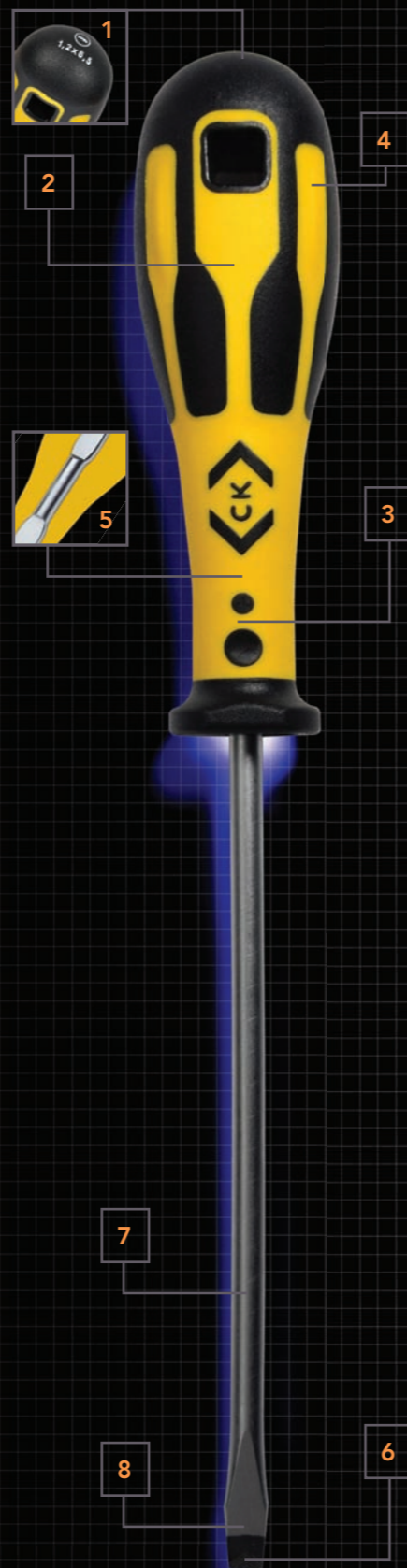

dextro™

featuring GRIP-TIP™ technology

DEXTRO



Screwdrivers - Slotted flared

ISO 2380, DIN 5264

| Item Number | Tip | Length | Tip Dia | Shank Dia | Weight |
|-------------|---------------|----------|--------------|---------------|--------|
| T49110-040 | 4.0mm 5/32" | 75mm 3" | 0.8mm 0.031" | 107mm 4 1/2" | 6 |
| T49110-055 | 5.5mm 7/32" | 100mm 4" | 1.0mm 0.039" | 120mm 4 3/4" | 6 |
| T49110-065 | 6.5mm 1/4" | 150mm 6" | 1.2mm 0.047" | 120mm 4 3/4" | 6 |
| T49110-100 | 10.0mm 25/64" | 200mm 8" | 1.6mm 0.063" | 135mm 5 1/16" | 6 |



Screwdrivers - Slotted parallel

ISO 2380-2, DIN 5264

| Item Number | Tip | Length | Tip Dia | Shank Dia | Weight |
|--------------|-------------|-----------|--------------|--------------|--------|
| T49125-025 | 3.0mm 1/8" | 75mm 3" | 0.4mm 0.016" | 95mm 3 3/4" | 6 |
| T49125-030 | 3.0mm 1/8" | 75mm 3" | 0.5mm 0.020" | 95mm 3 3/4" | 6 |
| T49125-03025 | 3.0mm 1/8" | 250mm 10" | 0.5mm 0.020" | 95mm 3 3/4" | 6 |
| T49125-035 | 3.5mm 9/64" | 100mm 4" | 0.6mm 0.024" | 95mm 3 3/4" | 6 |
| T49125-040 | 4.0mm 5/32" | 125mm 5" | 0.8mm 0.031" | 107mm 4 1/2" | 6 |
| T49125-055 | 5.5mm 7/32" | 150mm 6" | 1.0mm 0.039" | 120mm 4 3/4" | 6 |



Screwdrivers - PH

ISO 8764

| Item Number | Tip | Length | Tip Dia | Shank Dia | Weight |
|-------------|-----|-------------|--------------|---------------|--------|
| T49113-0 | PZ0 | 60mm 2 3/8" | 3.5mm 5/16" | 95mm 3 3/4" | 6 |
| T49113-1 | PZ1 | 75mm 3" | 5.0mm 3/16" | 107mm 4 1/2" | 6 |
| T49113-1250 | PZ1 | 250mm 10" | 5.0mm 3/16" | 107mm 4 1/2" | 6 |
| T49113-2 | PZ2 | 150mm 6" | 6.0mm 15/64" | 120mm 4 3/4" | 6 |
| T49113-2250 | PZ2 | 250mm 10" | 6.0mm 15/64" | 120mm 4 3/4" | 6 |
| T49113-3 | PZ3 | 150mm 6" | 8.0mm 5/16" | 135mm 5 1/16" | 6 |



Screwdrivers - PH

ISO 8764

| Item Number | Tip | Length | Tip Dia | Shank Dia | Weight |
|-------------|-----|-------------|--------------|---------------|--------|
| T49112-0 | PH0 | 60mm 2 3/8" | 3.5mm 5/16" | 95mm 3 3/4" | 6 |
| T49112-1 | PH1 | 80mm 3 1/8" | 5.0mm 3/16" | 107mm 4 1/2" | 6 |
| T49112-1250 | PH1 | 250mm 10" | 5.0mm 3/16" | 107mm 4 1/2" | 6 |
| T49112-2 | PH2 | 100mm 4" | 6.0mm 15/64" | 120mm 4 3/4" | 6 |
| T49112-2250 | PH2 | 250mm 10" | 6.0mm 15/64" | 120mm 4 3/4" | 6 |
| T49112-3 | PH3 | 150mm 6" | 8.0mm 5/16" | 135mm 5 1/16" | 6 |



Screwdrivers - TX

| Item Number | Tip | Length | Tip Dia | Shank Dia | Weight |
|-------------|------|--------------|--------------|---------------|--------|
| T49117-06 | T 06 | 70mm 2 3/4" | 3.0mm 1/8" | 95mm 3 3/4" | 6 |
| T49117-07 | T 07 | 70mm 2 3/4" | 3.0mm 1/8" | 95mm 3 3/4" | 6 |
| T49117-08 | T 08 | 70mm 2 3/4" | 3.0mm 1/8" | 95mm 3 3/4" | 6 |
| T49117-09 | T 09 | 70mm 2 3/4" | 3.0mm 1/8" | 95mm 3 3/4" | 6 |
| T49117-10 | T 10 | 80mm 3 1/8" | 3.0mm 1/8" | 107mm 4 1/2" | 6 |
| T49117-15 | T 15 | 80mm 3 1/8" | 3.5mm 9/64" | 107mm 4 1/2" | 6 |
| T49117-20 | T 20 | 90mm 3 1/2" | 4.0mm 5/32" | 107mm 4 1/2" | 6 |
| T49117-25 | T 25 | 90mm 3 1/2" | 4.5mm 11/64" | 107mm 4 1/2" | 6 |
| T49117-27 | T 27 | 110mm 4 1/4" | 5.5mm 7/32" | 120mm 4 3/4" | 6 |
| T49117-30 | T 30 | 110mm 4 1/4" | 6.0mm 15/64" | 120mm 4 3/4" | 6 |
| T49117-40 | T 40 | 120mm 4 3/4" | 7.0mm 9/32" | 135mm 5 1/16" | 6 |

CONTENTS: 1 x slotted flared, sizes: 4.0 x 75, 5.5 x 100 & 6.5 x 150mm. 1 x slotted parallel, size: 3.0 x 75mm. 1 x PZ, sizes: 0 x 60, 1 x 80 & 2 x 100mm.



**Screwdriver set -
7 Piece SL/PZ**

DIN ISO 2380, DIN ISO 8764

| Item Number | |
|-------------|---|
| T49163 | 1 |

CONTENTS: 1 x slotted flared, sizes: 4.0 x 75, 5.5 x 100 & 6.5 x 150mm. 1 x slotted parallel, size: 3.0 x 75mm. 1 x PH, sizes: 0 x 60, 1 x 80 & 2 x 100mm.



**Screwdriver set -
7 Piece SL/PH**

DIN ISO 2380, DIN ISO 8764

| Item Number | |
|-------------|---|
| T49162 | 1 |

CONTENTS: 1 x slotted flared, sizes: 4.0 x 75, 5.5 x 100 & 6.5 x 150mm. 1 x PZ, sizes: 1 x 80 & 2 x 100mm.



**Screwdriver set -
5 Piece SL/PZ**

DIN ISO 2380, DIN ISO 8764

| Item Number | |
|-------------|---|
| T49153 | 1 |

CONTENTS: 6 x slotted flared, sizes: 5.5 x 100, 6.5 x 150 & 10.0 x 200mm. 6 x slotted parallel, sizes: 3.0 x 75 & 4.0 x 125mm. 6 x PZ, sizes: 0 x 60, 1 x 80, 2 x 100 & 2 x 250mm. 6 x PH, sizes: 1 x 80 & 2 x 100mm.



Top sellers display

| Item Number | | |
|-------------|-----------------------|---|
| DEXTRO-TS | stock, shelf & header | 1 |

- Optional countertop Z-frame available



Countertop Z-frame

| Item Number | |
|-------------|---|
| M0162 | 1 |

CONTENTS: 6 x slotted flared, sizes: 4.0 x 75, 5.5 x 100, 6.5 x 150 & 10.0 x 200mm. 6 x slotted parallel, sizes: 2.5 x 75, 3.0 x 75, 3.0 x 250, 3.5 x 100, 4.0 x 125 & 5.5 x 150mm. 6 x PH, size: 0 x 60mm.



**Full range display -
Shelf 1**

| Item Number | | |
|-------------|-----------------------|---|
| DEXTRO-S1 | stock, shelf & header | 1 |

CONTENTS: 6 x PZ, sizes: 0 x 60, 1 x 80, 1 x 250, 2 x 100, 2 x 250 & 3 x 150mm. 6 x PH, sizes: 1 x 80, 1 x 250, 2 x 100, 2 x 250 & 3 x 150mm.

Shelf 2

| Item Number | | |
|-------------|-----------------------|---|
| DEXTRO-S2 | stock, shelf & header | 1 |

CONTENTS: 6 x TX, sizes: 6 x 70, 7 x 70, 8 x 70, 9 x 70, 10 x 80, 15 x 80, 20 x 90, 25 x 90, 27 x 110, 30 x 110 & 40 x 120mm.

Shelf 3

| Item Number | | |
|-------------|-----------------------|---|
| DEXTRO-S3 | stock, shelf & header | 1 |

HD CLASSIC

CLASSIC HEAVY DUTY SCREWDRIVERS

KLASSISCHE SCHWERLASTSCHRAUBENDREHER
TOURNEVIS HAUTES PERFORMANCES CLASSIQUES
DESTORNILLADORES CLASSIC PARA TRABAJOS PESADOS



- 1 Shatter resistant acetate handle - wipe clean, oil & acid resistant**
Splittersicherer Azetathandgriff - Reinigung durch Abwischen, öl- und säurefest
Manche en acétate incassable - facile à nettoyer et résistant aux huiles et aux attaques acides
Mango de acetato resistente a los choques, de fácil limpieza y resistentes al aceite y ácido
- 2 Large square shape handle design for maximum torque**
Großer viereckiger Handgriff für maximales Drehmoment
Manche de forme carrée de grandes dimensions pour un couple maximum
Diseño de mango grande y cuadrado para conseguir una máxima torsión
- 3 Handle injection moulded directly to blade giving the ultimate bond for increased reliability & durability**
Direkter Spritzguss des Handgriffs mit dem Schaft ergibt absolute Verbindung für erhöhte Zuverlässigkeit und Dauerhaftigkeit
Manche moulé par injection directement sur la lame, gage de la meilleure des adhérences pour une fiabilité et une durabilité accrues
Mango de inyección moldeado directamente en la varilla proporcionando el refuerzo fundamental para una mayor fiabilidad y durabilidad
- 4 Anti roll flats to prevent the screwdriver rolling off sloping surfaces**
Flächen am Handgriff verhindern das Abrollen des Schraubendrehers von rutschigen Oberflächen
Facettes anti-roulis pour empêcher le tournevis de rouler sur les plans inclinés
Plataformas antideslizantes para evitar que el destornillador se desplace en superficies inclinadas
- 5 Chrome plated toughened alloy steel blade for increased strength & durability**
Verchromter und verstärkter Schaft aus legiertem Stahl für erhöhte Festigkeit und Dauerhaftigkeit
Lames en acier allié durci chromé pour une résistance et une durabilité accrues
Varilla de aleación de acero endurecida, cromada para mayor resistencia y durabilidad
- 6 Precision machined tip for an exact screw fit & damage free screwdriving**
Präzise bearbeitete Spitze für exakte Anpassungen an die Schrauben und beschädigungsfreies Eindrehen
Pointe à usinage de précision pour un logement exact dans la tête de vis et un vissage sans dommages
Punta mecanizada de precisión para el ajuste exacto del tornillo y sin causar daños al atornillar



HDclassic

HD CLASSIC



Screwdrivers - Slotted flared

DIN 5264, ISO 2380-2

| Item Number | Blade Width | Blade Length | Blade Thickness | Blade Diameter | Blade Tip Length | Quantity |
|-------------|-------------|--------------|-----------------|----------------|------------------|----------|
| T4810 03 | 5mm 3/16" | 75mm 3" | 0.8mm 0.03" | 90mm 3 1/2" | 6 | |
| T4810 04 | 6mm 1/8" | 100mm 4" | 1.0mm 0.04" | 100mm 4" | 6 | |
| T4810 05 | 7mm 9/32" | 125mm 5" | 1.0mm 0.04" | 100mm 4" | 6 | |
| T4810 06 | 8mm 5/16" | 150mm 6" | 1.2mm 0.05" | 110mm 4 1/4" | 6 | |
| T4810 08 | 9mm 11/32" | 200mm 8" | 1.2mm 0.05" | 120mm 4 3/4" | 6 | |
| T4810 10 | 10mm 3/8" | 250mm 10" | 1.6mm 0.06" | 130mm 5 1/8" | 6 | |
| T4810 12 | 12mm 1/2" | 300mm 12" | 2.0mm 0.08" | 130mm 5 1/8" | 6 | |



Screwdrivers - Slotted parallel

DIN 5264, ISO 2380-2

| Item Number | Blade Width | Blade Length | Blade Thickness | Blade Diameter | Blade Tip Length | Quantity |
|-------------|--------------|--------------|-----------------|----------------|------------------|----------|
| T4965 03 | 3mm 1/8" | 75mm 3" | 0.5mm 0.02" | 70mm 2 3/4" | 6 | |
| T4975 06 | 3mm 1/8" | 150mm 6" | 0.5mm 0.02" | 80mm 3 1/8" | 6 | |
| T4975 08 | 3mm 1/8" | 200mm 8" | 0.5mm 0.02" | 80mm 3 1/8" | 6 | |
| T4965 04 | 4mm 5/32" | 100mm 4" | 0.8mm 0.03" | 80mm 3 1/8" | 6 | |
| T4975 10 | 4mm 5/32" | 250mm 10" | 0.8mm 0.03" | 80mm 3 1/8" | 6 | |
| T4965 05 | 4.5mm 11/64" | 125mm 5" | 0.8mm 0.03" | 80mm 3 1/8" | 6 | |
| T4965 06 | 5mm 3/16" | 150mm 6" | 0.8mm 0.03" | 90mm 3 1/2" | 6 | |
| T4965 08 | 6mm 1/8" | 300mm 12" | 0.8mm 0.03" | 90mm 3 1/2" | 6 | |
| T4965 12 | 6mm 1/8" | 300mm 12" | 0.8mm 0.03" | 90mm 3 1/2" | 6 | |



Screwdrivers - PZ

ISO 8764

| Item Number | Blade Width | Blade Length | Blade Thickness | Blade Diameter | Blade Tip Length | Quantity |
|-------------|-----------------|--------------|-----------------|----------------|------------------|----------|
| T4813 0 | PZ0 3.5mm 3/16" | 60mm 2 1/2" | 70mm 2 3/4" | 6 | | |
| T4813 1 | PZ1 5mm 3/16" | 80mm 3 1/8" | 90mm 3 1/2" | 6 | | |
| T4987 1 | PZ1 5mm 3/16" | 250mm 10" | 100mm 4" | 6 | | |
| T4813 2 | PZ2 6mm 1/8" | 100mm 4" | 100mm 4" | 6 | | |
| T4987 2 | PZ2 6mm 1/8" | 250mm 10" | 110mm 4 1/4" | 6 | | |
| T4813 3 | PZ3 8mm 5/16" | 150mm 6" | 110mm 4 1/4" | 6 | | |
| T4813 4 | PZ4 10mm 3/8" | 200mm 8" | 120mm 4 3/4" | 6 | | |

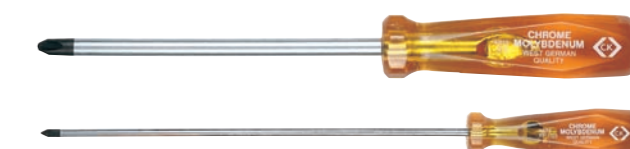

Screwdrivers - PH

ISO 8764

| Item Number | Blade Width | Blade Length | Blade Thickness | Blade Diameter | Blade Tip Length | Quantity |
|-------------|-----------------|--------------|-----------------|----------------|------------------|----------|
| T4812 0 | PH0 3.5mm 3/16" | 65mm 2 1/2" | 70mm 2 3/4" | 6 | | |
| T4812 1 | PH1 5mm 3/16" | 80mm 3 1/8" | 90mm 3 1/2" | 6 | | |
| T4977 1 | PH1 5mm 3/16" | 250mm 10" | 100mm 4" | 6 | | |
| T4812 2 | PH2 6mm 1/8" | 100mm 4" | 100mm 4" | 6 | | |
| T4977 2 | PH2 6mm 1/8" | 250mm 10" | 110mm 4 1/4" | 6 | | |
| T4812 3 | PH3 8mm 5/16" | 150mm 6" | 110mm 4 1/4" | 6 | | |
| T4812 4 | PH4 10mm 3/8" | 200mm 8" | 120mm 4 3/4" | 6 | | |



Screwdrivers - Stubby slotted

DIN 5264, ISO 2380-2

| Item Number | Blade Width | Blade Length | Blade Thickness | Blade Diameter | Blade Tip Length | Quantity |
|-------------|-------------|--------------|-----------------|----------------|------------------|----------|
| T4814 25 | 6.5mm 1/4" | 25mm 1" | 1.2mm 0.05" | 60mm 2 3/8" | 6 | |
| T4814 31 | 8mm 5/16" | 25mm 1" | 1.2mm 0.05" | 60mm 2 3/8" | 6 | |



Screwdrivers - Stubby PZ

ISO 8764

| Item Number | + | Ø | ↔ | ↔ | 📦 |
|-------------|-----|-----------|---------|-------------|---|
| T4816 1 | PZ1 | 5mm 3/16" | 25mm 1" | 60mm 2 3/8" | 6 |
| T4816 2 | PZ2 | 6mm 1/4" | 25mm 1" | 60mm 2 3/8" | 6 |



Screwdrivers - Stubby PH

ISO 8764

| Item Number | + | Ø | ↔ | ↔ | 📦 |
|-------------|------|-----------|---------|-------------|---|
| T4815 1 | PH 1 | 5mm 3/16" | 25mm 1" | 60mm 2 3/8" | 6 |
| T4815 2 | PH 2 | 6mm 1/4" | 25mm 1" | 60mm 2 3/8" | 6 |



Screwdrivers - Slotted strike through

| Item Number | + | ↔ | ↔ | ↔ | 📦 |
|-------------|-----------|-----------|-------------|--------------|---|
| T4811 04 | 6mm 1/4" | 100mm 4" | 1.0mm 0.04" | 100mm 4" | 6 |
| T4811 06 | 8mm 5/16" | 150mm 6" | 1.2mm 0.05" | 110mm 4 1/4" | 6 |
| T4811 08 | 10mm 3/8" | 200mm 8" | 1.6mm 0.06" | 120mm 4 3/4" | 6 |
| T4811 10 | 13mm 1/2" | 250mm 10" | 2.0mm 0.08" | 130mm 5 1/8" | 6 |



Nut spinners

DIN 3125

| Item Number | Ø | ↔ | ↔ | 📦 |
|-------------|-------|--------------|--------------|---|
| T4334M 03 | 3mm | 130mm 5 1/8" | 90mm 3 1/2" | 3 |
| T4334M 035 | 3.5mm | 130mm 5 1/8" | 90mm 3 1/2" | 3 |
| T4334M 04 | 4mm | 130mm 5 1/8" | 90mm 3 1/2" | 3 |
| T4334M 045 | 4.5mm | 130mm 5 1/8" | 90mm 3 1/2" | 3 |
| T4334M 05 | 5mm | 130mm 5 1/8" | 90mm 3 1/2" | 3 |
| T4334M 055 | 5.5mm | 130mm 5 1/8" | 90mm 3 1/2" | 3 |
| T4334M 06 | 6mm | 130mm 5 1/8" | 90mm 3 1/2" | 3 |
| T4334M 07 | 7mm | 130mm 5 1/8" | 100mm 4" | 3 |
| T4334M 08 | 8mm | 130mm 5 1/8" | 100mm 4" | 3 |
| T4334M 09 | 9mm | 130mm 5 1/8" | 100mm 4" | 3 |
| T4334M 10 | 10mm | 130mm 5 1/8" | 100mm 4" | 3 |
| T4334M 11 | 11mm | 120mm 4 3/4" | 110mm 4 1/4" | 3 |
| T4334M 12 | 12mm | 120mm 4 3/4" | 110mm 4 1/4" | 3 |
| T4334M 13 | 13mm | 120mm 4 3/4" | 110mm 4 1/4" | 3 |

CONTENTS: 1 x slotted flared, sizes: 6.0 x 100, 6.5 x 25, 7.0 x 125 & 8.0 x 100mm. 1 x slotted parallel, sizes: 3.0 x 75 & 4.0 x 100mm. 1 x PZ, sizes: 1 x 80 & 2 x 100mm.



Screwdriver Set - 8 Piece SL/PZ

| Item Number | 📦 |
|-------------|---|
| T4999B | 1 |

CONTENTS: 6 x slotted flared, sizes: 6.5 x 25, 6.0 x 100 & 8.0 x 150mm. 6 x slotted parallel, sizes: 3.0 x 75 & 4.0 x 100mm. 6 x PZ, sizes: 0 x 60, 1 x 80, 2 x 25 & 2 x 100mm. 6 x PH, sizes: 1 x 80 & 2 x 100mm.



Top sellers display

| Item Number | i | 📦 |
|--------------|-----------------------|---|
| HDCLASSIC-TS | stock, shelf & header | 1 |

- Optional countertop Z-frame available



Countertop Z-frame

| Item Number | 📦 |
|-------------|---|
| M0162 | 1 |

CONTENTS: 6 x slotted parallel, sizes: 3.0 x 150, 3.0 x 200, 4.0 x 250 & 6.0 x 300mm. 6 x slotted flared, sizes: 5.0 x 75, 6.0 x 100, 7.0 x 125, 8.0 x 150, 9.0 x 200, 10.0 x 250 & 12.0 x 300mm.



Full range display - Shelf 1

| Item Number | i | 📦 |
|--------------|-----------------------|---|
| HDCLASSIC-S1 | stock, shelf & header | 1 |

CONTENTS: 12 x slotted parallel, sizes: 3.0 x 75 & 4.0 x 100mm. 6 x slotted parallel, sizes: 4.5 x 125, 5.0 x 150 & 5.0 x 200mm. 6 x slotted strike-through, sizes: 6.0 x 100, 8.0 x 150, 10.0 x 200 & 13.0 x 250mm.

Shelf 2

| Item Number | i | 📦 |
|--------------|-----------------------|---|
| HDCLASSIC-S2 | stock, shelf & header | 1 |

CONTENTS: 12 x PZ, size: 2 x 100mm. 6 x PZ, sizes: 0 x 60, 1 x 80, 2 x 100, 3 x 150 & 4 x 200mm. 6 x PH, sizes: 0 x 65, 1 x 80, 2 x 100, 3 x 150 & 4 x 200mm.

Shelf 3

| Item Number | i | 📦 |
|--------------|-----------------------|---|
| HDCLASSIC-S3 | stock, shelf & header | 1 |

CONTENTS: 12 x slotted flared, sizes: 6.5 x 25mm. 6 x slotted flared, sizes: 8.0 x 25mm. 6 x PZ, sizes: 1 x 25, 2 x 25, 1 x 250 & 2 x 250mm. 6 x PH, sizes: 1 x 25, 2 x 25, 1 x 250 & 2 x 250mm.

Shelf 4

| Item Number | i | 📦 |
|--------------|-----------------------|---|
| HDCLASSIC-S4 | stock, shelf & header | 1 |

TRITON XLS PROFESSIONAL GENERAL PURPOSE SCREWDRIVERS

PROFESSIONELLE MEHRZWECKSCHRAUBENDREHER
TOURNEVIS PROFESSIONNELS A USAGE UNIVERSEL
DESTORNILLADORES DE USO GENERAL PARA PROFESIONALES



1 Tip type marking for easy identification

Kopf Markierung zur einfachen Erkennung
Marquage du type de pointe pour une identification aisée
Tope superior marcado con el tipo de punta para facilitar su identificación

2 Large soft grip tri-lobe handle for exceptional comfort & high torque turns

Großer dreiflügeliger Handgriff mit weichem Griff für außergewöhnlichen Komfort und hohes Drehmoment
Grand manche à trois lobes à revêtement souple pour un confort exceptionnel et des couples de vissage élevés
Mango grande de agarre suave con tres salientes para un confort excepcional y alta torsión de apriete

3 Handle injection moulded directly to blade giving the ultimate bond for increased reliability & durability

Direkter Spritzguss des Handgriffs mit dem Schaft ergibt absolute Verbindung für erhöhte Zuverlässigkeit und Dauerhaftigkeit
Manche moulé par injection directement sur la lame, gage de la meilleure des adhérences pour une fiabilité et une durabilité accrues
Mango de inyección moldeado directamente en la varilla proporcionando el refuerzo fundamental para una mayor fiabilidad y durabilidad

4 Anti roll flats to prevent the screwdriver rolling off sloping surfaces

Flächen am Handgriff verhindern das Abrollen des Schraubendrehers von rutschigen Oberflächen
Facettes anti-roulis pour empêcher le tournevis de rouler sur les plans inclinés
Plataformas antideslizantes para evitar que el destornillador se desplace en superficies inclinadas

5 Chrome plated, toughened alloy steel blade for increased strength & durability

Verchromter und verstärkter Schaft aus legiertem Stahl für erhöhte Festigkeit und Dauerhaftigkeit
Lames en acier allié durci chromé pour une résistance et une durabilité accrues
Varilla de aleación acero endurecida, cromada para mayor resistencia y durabilidad

6 Magnetic tip holds the screw securely to the tip to aid positioning & setting

Magnetische Bit-Halterung hält die Schraube sicher an der Spitze und hilft bei der Positionierung und dem Ansetzen der Schraube
La pointe magnétisée retient solidement la vis au bout de l'outil et facilite l'approche et la pose
Punta magnética que mantiene el tornillo de forma segura en la punta para ayudar a su colocación y ajuste



TRITON XLS



Screwdrivers - Slotted flared

DIN ISO 2380

| Item Number | Blade Width | Blade Length | Blade Thickness | Blade Diameter | Blade Material |
|-------------|-------------|--------------|-----------------|----------------|----------------|
| T4720-055 | 5.5mm 7/32" | 100mm 4" | 1.0mm 0.039" | 100mm 4" | 6 |
| T4720-065 | 6.5mm 1/4" | 150mm 6" | 1.2mm 0.047" | 108mm 4 1/4" | 6 |
| T4720-100 | 10mm 3/8" | 200mm 8" | 1.6mm 0.063" | 118mm 4 5/8" | 6 |



Screwdrivers - Slotted parallel

DIN ISO 2380

| Item Number | Blade Width | Blade Length | Blade Thickness | Blade Diameter | Blade Material |
|-------------|-------------|--------------|-----------------|----------------|----------------|
| T4725-030 | 3.0mm 1/8" | 75mm 3" | 0.6mm 0.024" | 89mm 3 5/8" | 6 |
| T4725-040 | 4.0mm 5/32" | 100mm 4" | 0.8mm 0.031" | 100mm 4" | 6 |
| T4725-055 | 5.5mm 7/32" | 250mm 10" | 1.0mm 0.039" | 100mm 4" | 6 |

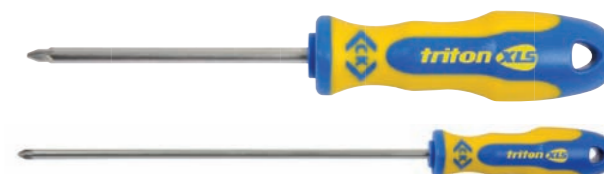

Screwdrivers - PZ

DIN ISO 8764

| Item Number | Blade Width | Blade Length | Blade Thickness | Blade Diameter | Blade Material |
|-------------|-----------------|--------------|-----------------|----------------|----------------|
| T4723-0 | PZ0 3.0mm 1/8" | 60mm 2 3/8" | 89mm 3 5/8" | 6 | |
| T4723-1 | PZ1 5.0mm 3/16" | 75mm 3" | 100mm 4" | 6 | |
| T4723-1250 | PZ1 5.0mm 3/16" | 250mm 10" | 100mm 4" | 6 | |
| T4723-2 | PZ2 6.0mm 5/16" | 100mm 4" | 108mm 4 1/4" | 6 | |
| T4723-2250 | PZ2 6.0mm 5/16" | 250mm 10" | 108mm 4 1/4" | 6 | |
| T4723-3 | PZ3 8.0mm 5/8" | 150mm 6" | 118mm 4 5/8" | 6 | |

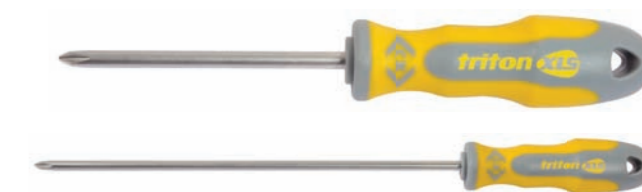

Screwdrivers - PH

DIN ISO 8764

| Item Number | Blade Width | Blade Length | Blade Thickness | Blade Diameter | Blade Material |
|-------------|-----------------|--------------|-----------------|----------------|----------------|
| T4722-0 | PH0 3.0mm 1/8" | 60mm 2 3/8" | 89mm 3 5/8" | 6 | |
| T4722-1 | PH1 5.0mm 3/16" | 75mm 3" | 100mm 4" | 6 | |
| T4722-1250 | PH1 5.0mm 3/16" | 250mm 10" | 100mm 4" | 6 | |
| T4722-2 | PH2 6.0mm 5/16" | 100mm 4" | 108mm 4 1/4" | 6 | |
| T4722-2250 | PH2 6.0mm 5/16" | 250mm 10" | 108mm 4 1/4" | 6 | |
| T4722-3 | PH3 8.0mm 5/8" | 150mm 6" | 118mm 4 5/8" | 6 | |



CONTENTS: 1 x slotted flared, sizes: 5.5 x 100 & 6.5 x 150mm.
1 x slotted parallel, size: 4.0 x 100mm. 1 x PZ, sizes: 1 x 75 & 2 x 100mm.



**Screwdriver set -
5 Piece SL/PZ**

DIN ISO 2380, DIN ISO 8764

| Item Number | |
|-------------|---|
| T4727 | 1 |

CONTENTS: 1 x slotted flared, sizes: 5.5 x 100 & 6.5 x 150mm.
1 x slotted parallel, size: 4.0 x 100mm. 1 x PH, sizes: 1 x 75 & 2 x 100mm.



**Screwdriver set -
5 Piece SL/PH**

DIN ISO 2380, DIN ISO 8764

| Item Number | |
|-------------|---|
| T4726 | 1 |

CONTENTS: 1 x slotted parallel, sizes: 2.5 x 75, 4.0 x 100 & 5.5 x 125mm. 1 x PZ, sizes: 1 x 80 & 2 x 100mm.



**Screwdriver set -
Insulated 5 Piece SL/PZ**

DIN ISO 2380, DIN ISO 8764, IEC 60900:2004

| Item Number | |
|-------------|---|
| T4729 | 1 |

CONTENTS: 1 x slotted parallel, sizes: 2.5 x 75, 4.0 x 100 & 5.5 x 125mm. 1 x PH, sizes: 1 x 80 & 2 x 100mm.



**Screwdriver set -
Insulated 5 Piece SL/PH**

DIN ISO 2380, DIN ISO 8764, IEC 60900:2004

| Item Number | |
|-------------|---|
| T4728 | 1 |

CONTENTS: 6 x slotted flared, sizes: 5.5 x 100, 6.5 x 150 & 10.0 x 200mm. 6 x slotted parallel, sizes: 3.0 x 75 & 4.0 x 100mm. 6 x PZ, sizes: 0 x 60, 1 x 75, 2 x 100 & 2 x 250mm. 6 x PH, sizes: 1 x 75 & 2 x 100mm.



Top sellers display

| Item Number | | |
|--------------|-----------------------|---|
| TRITONXLS-TS | stock, shelf & header | 1 |

- Optional countertop Z-frame available



Countertop Z-frame

| Item Number | |
|-------------|---|
| M0162 | 1 |

CONTENTS: 6 x slotted flared, sizes: 5.5 x 100, 6 x 200 & 6.5 x 150mm. 12 x slotted parallel, size: 4.0 x 100mm. 6 x slotted parallel, sizes: 3.0 x 75 & 5.5 x 250mm. 6 x PZ, sizes: 1 x 250 & 2 x 250mm. 6 x PH, sizes: 1 x 250 & 2 x 250mm.



**Full range display -
Shelf 1**

| Item Number | | |
|--------------|-----------------------|---|
| TRITONXLS-S1 | stock, shelf & header | 1 |

CONTENTS: 12 x PZ, sizes: 1 x 75 & 2 x 100mm. 6 x PZ, sizes: 0 x 60 & 3 x 150mm. 12 x PH, size: 2 x 100mm. 6 x PH, sizes: 0 x 60, 1 x 75 & 3 x 150mm.

Shelf 2

| Item Number | | |
|--------------|-----------------------|---|
| TRITONXLS-S2 | stock, shelf & header | 1 |

MAINSTESTERS

- Premium quality VDE approved for assured safety
- Neon light for high visibility
- Finger slip guard for added safety
- Integrated pocket clip



VDE Mainstester - 125-250V AC

VDE0680 P6E

| Item Number | Length | Tip | Quantity |
|-------------|--------|-------|----------|
| 440008 | 150mm | 3mm | 12 |
| 440009 | 190mm | 3.5mm | 12 |

- VDE approved mainstester for assured safety
- Neon light for high visibility



VDE Mainstester - 220-250V AC

VDE0680 P6E

| Item Number | Length | Tip | Tip | Quantity |
|-------------|--------|-----|-------|----------|
| 440012 | 100mm | 4mm | 0.6mm | 12 |

- VDE approved mainstester for assured safety
- Neon light for high visibility
- Pocket clip



VDE Mainstester with pocket clip - 220-250V AC

VDE0680 P6E

| Item Number | Length | Tip | Tip | Quantity |
|-------------|--------|-----|-------|----------|
| 440007 | 65mm | 3mm | 0.5mm | 12 |

- Extended shaft for long reach applications
- Insulated for protection
- Neon light for high visibility



Mainstester - 100-250V AC

| Item Number | Length | Tip | Tip | Quantity |
|-------------|--------|-----|-------|----------|
| 440013 | 120mm | 4mm | 0.6mm | 12 |



Mainstester display box - 20 Piece 100-250V AC

| Item Number | Description | Quantity |
|-------------|---------------|----------|
| 540014 | box of 440013 | 1 |

RATCHET SCREWDRIVERS

- Hi-torque ratchet mechanism for durability
- Left & right hand rotation plus lock action for convenience
- Magnetic shaft for secure bit retention
- Cushion grip handle with convenient internal bits storage compartment

CONTENTS: Ratchet driver. 1/4" square drive adapter. Screwdriver bits: 1 x slotted, sizes: 3.0, 4.0, 4.5, 5.0, 6.0, 7.0, 8.0 & 9.0mm. 1 x PH, sizes: 0, 1, 2 & 3. 1 x PZ, sizes: 0, 1, 2 & 3. 1 x hexagon, sizes: 1.5, 2.0, 2.5, 3.0, 4.0, 5.0, 5.5 & 6.0mm. 1 x TX tamperproof, sizes: 8, 10, 15, 20, 25, 27, 30 & 40. Sockets: 1 x metric, sizes: 6, 7, 8, 10, 11 & 13mm. 1 x imperial, sizes: 3/16, 1/4, 5/16, 11/32, 3/8 & 7/16".



Ratchet screwdriver bit & socket set

| Item Number | Description | Quantity |
|-------------|--------------|----------|
| T4826D | 46 piece set | 3 |

- Hi-torque ratchet mechanism for durability
- Left & right hand rotation plus lock action for convenience
- Magnetic shaft for secure bit retention
- Cushion grip handle with convenient internal bits storage compartment

CONTENTS: Ratchet screwdriver. Screwdriver bits: 1 x slotted, sizes: 3.0, 4.7 & 6.3mm. 1 x PH, size: 2. 1 x PZ, sizes: 1, 2 & 3. 1 x hexagon, sizes: 3, 4 & 5mm.



Ratchet screwdriver & bits set

| Item Number | Description | Quantity |
|-------------|--------------|----------|
| T4829D | 11 piece set | 3 |

IMPACT DRIVER & BITS

- Heavy duty steel body - strong and durable
- Chrome plated for corrosion protection
- Shock absorbing grip for comfort & protection
- Twist to reverse function for convenience
- High strength chrome vanadium bits
- Steel case for convenient storage

CONTENTS: Impact driver. 1/2" to 1/4" drive adapter. Screwdriver bits: 1 x slotted, sizes: 8 & 10mm. 1 x PH, sizes: 2 & 3.

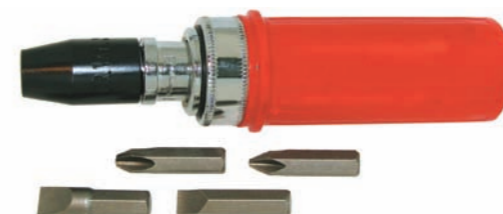

Impact driver set

| Item Number | Description | Quantity |
|-------------|-------------|----------|
| T4928 | 6 piece set | 2 |

Impact driver bits

| Item Number | Tip | Length | Quantity |
|-------------|-----|------------|----------|
| T4928 362 | + | PH2 x 36mm | 10 |
| T4928 363 | + | PH3 x 36mm | 10 |
| T4928 36M08 | ● | 8 x 36mm | 10 |
| T4928 36M10 | ● | 10 x 36mm | 10 |
| T4928 36M12 | ● | 12 x 36mm | 10 |
| T4928 36P2 | * | PZ2 x 36mm | 10 |
| T4928 36P3 | * | PZ3 x 36mm | 10 |
| T4928 802 | + | PH2 x 80mm | 10 |
| T4928 803 | + | PH3 x 80mm | 10 |

BRADAWLS

- Nickel plated hardened steel blade for a long life
- Shatterproof ball ended acetate handle for comfort and safety



Bradawl - Round

| Item Number | Tip | Length | Length | Quantity |
|-------------|-----|--------|------------------------|----------|
| T4835 | 6mm | 7/32" | 100mm 4" / 85mm 3 1/4" | 6 |



Bradawl - Square

| Item Number | Tip | Length | Length | Quantity |
|-------------|-------|--------|-------------|----------|
| T4831 2 | 100mm | 4" | 85mm 3 1/4" | 6 |



Bradawl display box - 50 Square assorted length

| Item Number | Description | Quantity |
|-------------|-------------------|----------|
| T4831 | 50 in counter box | 1 |

TOOL KITS

WERKZEUGSÄTZE
TROUSSES ET SACOCHES D'OUTILLAGE
CONJUNTOS DE HERRAMIENTAS

50-51**JOKARI CABLE KNIVES**

JOKARI-KABELMESSER
COUTEAUX À DÉNUDER JOKARI
JOKARI CUCHILLOS PARA CABLES

52-53**JOKARI CABLE STRIPPERS**

JOKARI-KABELABISOLIERER
OUTILS À DÉNUDER JOKARI
ALICATES PELACABLES JOKARI

53**JOKARI AUTO CABLE/WIRE STRIPPERS**

AUTOM. JOKARI-KABEL-/
DRAHTABISOLIERER
OUTILS À DÉNUDER AUTOMATIQUES
POUR CÂBLES ET FILS JOKARI
JOKARI ALICATES PELACABLES/
PELAALAMBRES AUTOMÁTICOS

54**CABLE AND WIRE STRIPPING TOOLS**

KABEL- UND
DRAHTABISOLIERUNGSWERKZEUGE
OUTILS DE DÉNUDAGE DES CÂBLES
ET FILS
HERRAMIENTAS PARA PELAR CABLES
Y ALAMBRES

55**CABLE CUTTING**

KABEL SCHNEIDEN
COUPE CÂBLES
CORTAR CABLE

55-56**CABLE TIE GUNS**

KABELBINDERPISTOLE
PISTOLETS POUR LIGATEUR DE CÂBLES
PISTOLAS DE BRIDAS

56**DRAW TAPES**

EINZIEHBÄNDER
TIR-FILS
FLEJES (CINTA DE ACERO)

56**SWITCH KEYS**

SCHALTSCHRANKSCHLÜSSEL
CLÉS UNIVERSELLES
LLAVES EN CRUZ (MULTIFUNCIÓN)

57**SOLDERING IRONS**

LÖTKOLBEN
FERS À SOUDER
SOLDADORES

57**PUNCH DOWN TOOL**

AUFLEGEWERKZEUG
OUTIL D'ENFICHAGE
HERRAMIENTA DE PERFORACIÓN

57**RE-THREADING TOOL**

GEWINDENACHSCHNEIDWERKZEUGE
OUTILS À REFILETER
HERRAMIENTAS DE ROSCADO

57

ELECTRICIAN'S TOOLS

ELEKTRIKERWERKZEUGE
AUTRES OUTILS D'ELECTRICIEN
HERRAMIENTAS DE ELECTRICISTA



TOOL KITS

CONTENTS: Technician's tool case. Redline VDE Combicutter3™ 165mm. Combination pliers 185mm. Snipe nose pliers 175mm. 1 x Dextro VDE screwdrivers, slotted, sizes: 2.5 x 75 & 4 x 100mm; PZ, sizes: 1 x 80 & 2 x 100mm; PH, sizes: 1 x 80 & 2 x 100mm; Modulo, size: 2. VDE mainstester. ST tape 5m/16ft. Junior hacksaw. Electrician's knife. Automatic wire strippers. Pocket level. Re-threading tool M3.5. Claw hammer.



Electrician's premium tool kit - UK

| Item Number | i | 📦 |
|-------------|--------------|---|
| 595003 | 19 piece kit | 1 |

CONTENTS: Tool wallet. Redline VDE combicutter1™ 160mm. Wire stripping pliers 200mm. Snipe nose pliers 170mm. 1 x Dextro VDE screwdriver, slotted, sizes: 2.5 x 75, 3.0 x 100 & 5.5 x 125mm; PZ, sizes: 1 x 80 & 2 x 100mm. VDE mainstester.



VDE Pliers & screwdrivers kit - PZ UK

| Item Number | i | 📦 |
|-------------|--------------|---|
| 331001 | 10 piece kit | 1 |

CONTENTS: Technician's tool case. Redline VDE side cutters 165mm. Combination pliers 175mm. Snipe nose pliers 175mm. 1 x Dextro VDE screwdriver, slotted, sizes: 2.5 x 75 & 4 x 100mm; PZ, sizes: 1 x 80 & 2 x 100mm; PH, sizes: 1 x 80 & 2 x 100mm; Modulo, sizes: 1 & 2. VDE mainstester. ST tape 8m. Mini hacksaw. Electrician's knife. Automatic wire strippers. Cable knife. Plasterboard saw.



Electrician's premium tool kit - European

| Item Number | i | 📦 |
|-------------|--------------|---|
| T1630 FKIT | 17 piece kit | 1 |

CONTENTS: Tool wallet. Redline VDE combicutter1™ 160mm. Wire stripping pliers 200mm. Snipe nose pliers 170mm. 1 x Dextro VDE screwdriver, slotted, sizes: 2.5 x 75, 3.0 x 100 & 5.5 x 125mm; PH, sizes: 1 x 80 & 2 x 100mm. VDE mainstester.



VDE Pliers & screwdrivers kit - PH UK

| Item Number | i | 📦 |
|-------------|--------------|---|
| 331002 | 10 piece kit | 1 |

CONTENTS: Electrician's tool belt set. Redline VDE combicutter3™ side cutters 165mm. Combination pliers 185mm. Snipe nose pliers 175mm. 1 x Dextro VDE screwdriver, slotted, sizes: 2.5 x 75, 5.5 x 125 & 6.5 x 150mm; PZ, size: 2 x 100; Modulo, size: 2. VDE mainstester. ST tape 5m/16ft. Junior hacksaw. Electrician's knife. Pocket level.



Electrician's toolbelt kit

| Item Number | i | 📦 |
|-------------|--------------|---|
| 595001 | 14 piece kit | 1 |

CONTENTS: Tool wallet. Redline VDE side cutters 160mm. Wire stripping pliers 200mm. Snipe nose pliers 170mm. 1 x Dextro VDE screwdriver, slotted, sizes: 2.5 x 75, 3.0 x 100 & 5.5 x 125mm; PZ, sizes: 1 x 80 & 2 x 100mm. VDE mainstester.



VDE Pliers & screwdrivers kit - PZ European

| Item Number | i | 📦 |
|-------------|--------------|---|
| 331003 | 10 piece kit | 1 |

CONTENTS: Tool wallet. RedLine VDE combicutter3™ 160mm. 1 x Dextro screwdriver, slotted, sizes: 3 x 100 & 4 x 100mm; PZ, size: 2. VDE mainstester. ST tape measure 5m/16ft. Electrician's scissors. Pocket level. Re-threading tool M3.5.



Electrician's core tool kit

| Item Number | i | 📦 |
|-------------|--------------|---|
| 595002 | 10 piece kit | 1 |

CONTENTS: Tool wallet. Redline VDE side cutters 160mm. Wire stripping pliers 200mm. Snipe nose pliers 170mm. 1 x Dextro VDE screwdriver, slotted, sizes: 2.5 x 75, 3.0 x 100 & 5.5 x 125mm; PH, sizes: 1 x 80 & 2 x 100mm. VDE mainstester.



VDE Pliers & screwdrivers kit - PH European

| Item Number | i | 📦 |
|-------------|--------------|---|
| 331004 | 10 piece kit | 1 |

JOKARI
original

PRECISION CABLE & WIRE STRIPPING TOOLS

Top quality products manufactured in Germany to the highest standards, Jokari products offer quick and easy cable & wire stripping without the risk of damage.

CABLE KNIVES



CABLE STRIPPERS



AUTO CABLE/WIRE STRIPPERS



JOKARI CABLE KNIVES

- Cutting blade automatically repositions from cutting around, to cutting along the sheath for fast and damage free stripping
- Adjustable cutting depth to prevent damage to the conductors
- High grade wear resistant polyamide construction - light and strong
- Spare cutting blade in the handle



Jokari cable knife

| Item Number | Ø | 📦 |
|-------------|--|---|
| T10160 | 4 - 16mm $\frac{5}{32}$ - $\frac{5}{16}$ " | 6 |
| T10270 | 8 - 28mm $\frac{5}{16}$ - $1\frac{1}{8}$ " | 6 |

- Fully insulated for safe working



Jokari cable knife - Insulated

| Item Number | Ø | 📦 |
|-------------|--|---|
| T10271 | 8 - 28mm $\frac{5}{16}$ - $1\frac{1}{8}$ " | 6 |

- Additional external hook & straight blade for convenience



Jokari cable knife with blade

| Item Number | Ø | 📦 |
|-------------|--|---|
| T10280 | 8 - 28mm $\frac{5}{16}$ - $1\frac{1}{8}$ " | 6 |

- Additional external hook & straight blade for convenience



Jokari economy cable knife with blade

| Item Number | Ø | 📦 |
|-------------|--|---|
| T10283 | 8 - 28mm $\frac{5}{16}$ - $1\frac{1}{8}$ " | 6 |

- Spare cutting blades for all Jokari cable knives

Jokari spare cutting blades

| Item Number | i | 📦 |
|-------------|-------------|----|
| T19000 | 3 piece set | 10 |

JOKARI CABLE STRIPPERS

- Razor sharp, preset stripping blades for fast, precise and damage free stripping of all common flat and oval cables
- Pre-set precision stripping blades for damage free wire stripping



Jokari cable stripper - Flat

| Item Number | mm ² / AWG | Ø | 📦 |
|-------------|--|---|---|
| T30140 | Wire stripping 0.8, 1.5, 2.5 / 20, 16, 14 | Cable stripping 12mm $\frac{1}{2}$ " | 6 |

- Razor sharp, preset stripping blades for fast, precise and damage free stripping of all common round cables



Jokari cable stripper - Round

| Item Number | Ø | 📦 |
|-------------|--|---|
| T30120 | Cable stripping 8 - 13mm $\frac{5}{16}$ - $\frac{1}{2}$ " | 6 |

- Razor sharp, preset stripping blades for fast, precise and damage free stripping of round cables
- Pre-set precision stripping blades for damage free wire stripping
- Retractable trimming knife blade for convenience
- Titanium-Nitride coated blades for increased durability



Jokari stripper - Round

| Item Number | mm ² / AWG | Ø | 📦 |
|-------------|--|--|---|
| T30155 | Wire stripping 0.2, 0.3, 0.8, 1.5, 2.5, 4.0 / 24, 22, 20, 16, 14, 12 | Cable stripping 8 - 13mm $\frac{5}{16}$ - $\frac{1}{2}$ " | 6 |

- Razor sharp, preset stripping blades for fast, precise and damage free stripping of datacomms cables
- Pre-set precision stripping blades for damage free wire stripping



Jokari cable stripper - Datacoms

| Item Number | mm ² / AWG | Ø | 📦 |
|-------------|--|---|---|
| T30160 | Wire stripping 0.2, 0.3, 0.8, 1.5, 2.5, 4.0 / 24, 22, 20, 16, 14, 12 | Cable stripping 5 - 15mm $\frac{3}{16}$ - $\frac{5}{16}$ " | 6 |

- Razor sharp, preset stripping blades for fast, precise and damage free stripping of all common coaxial cables
- Also suitable for stripping 3-core flex



Jokari cable stripper - Coaxial

| Item Number | mm ² / AWG | 📦 |
|-------------|---|---|
| T30010 | 4.8 & 7.5mm / $\frac{3}{16}$ & $\frac{5}{32}$ " | 6 |

JOKARI AUTO CABLE/WIRE STRIPPERS

- Fibreglass-reinforced polyamide construction for high strength and light weight
- Ergonomically designed for fatigue free, repetitive stripping
- Stripping length scale for consistent results

- Designed for solid & stranded wires
- Automatic wire size adjustment for convenience
- Integrated wire cutter



Jokari auto wire stripper - Single core

| Item Number | mm ² / AWG | |
|-------------|-----------------------|---|
| T20050 | 0.2 - 6.0 / 24 - 10 | 6 |

- Designed for stripping difficult insulations, e.g. PMMA fibre optic cables with PE sheath, PVC, rubber, silicon and TPE



Jokari auto wire stripper - Tough insulation

| Item Number | mm ² / AWG | |
|-------------|-----------------------|---|
| T20450 | 0.5 - 4.0 / 20 - 11 | 6 |

- Designed for flat twin and earth cables
- Automatic cable size adjustment for convenience



Jokari auto cable stripper - Flat

| Item Number | mm ² / AWG | |
|-------------|-----------------------|---|
| T20030 | 0.75 - 2.5 / 18 - 14 | 6 |

- Designed for larger diameter wire and 3-core PVC flex
- Automatic cable size adjustment for convenience



Jokari auto cable stripper - Round

| Item Number | mm ² / AWG | |
|-------------|-----------------------|---|
| T20090 | 6 - 16 / 10 - 5 | 6 |

- Designed for solid & stranded wires
- Automatic wire size adjustment for convenience



Jokari auto wire stripper - Side cutter

| Item Number | mm ² / AWG | |
|-------------|-----------------------|---|
| T20060 | 0.5 - 6.0 / 20 - 10 | 6 |

CABLE & WIRE STRIPPING TOOLS

- Designed for fatigue free, repetitive stripping of flat & round cable & wire
- Automatic wire size adjustment and stripping length stop for consistent results
- Integrated wire cutter and crimping jaws for convenience



Automatic wire stripper

| Item Number | i | |
|-------------|---|---|
| 495001 | Stripping - 0.2 - 6.0mm; Cutting - HRC 40 - 50; Crimping - 0.5 - 6.0mm terminals. | 3 |

- Dual purpose cable stripper and plastic tube cutting tool
- Cutting blade automatically repositions from cutting around, to cutting along the sheath for fast and damage free stripping
- Adjustable cutting depth for damage free stripping



Cable stripper - Kabifix

| Item Number | ∅ | |
|-------------|----------|---|
| 430004 | 6 - 28mm | 3 |

Cable stripper - Kabifix spare blade

| Item Number | |
|-------------|----|
| 395041 | 10 |

- Locking pocket knife with a durable, sharp, high carbon steel blade and wire stripping notch for fast and convenient cable & wire stripping



Electrician's knife

| Item Number | | |
|-------------|-------------|---|
| 484001 | 95mm 3 7/8" | 3 |

- Specially adapted knife for slitting the outer sheath of cables without damaging inner wire insulation
- Individually tested to 10,000V for safe live working up to 1,000V



VDE Cable sheath slitting knife

ASTM-F 1505, EN 60900, VDE0682/201

| Item Number | | |
|-------------|--------------|---|
| 484005 | 185mm 3 1/2" | 3 |

CABLE CUTTING

- Heavy duty, ratchet action cutters for effortlessly cutting of large diameter cable
- Hardened chrome molybdenum steel blade specially designed for cutting hard drawn copper, aluminium cable or 200 pair communications cable (Not for use on steel armoured cable)



Cable cutter - Ratchet

| Item Number | | ∅ | |
|-------------|-------|------|---|
| 430007 | 190mm | 32mm | 3 |

Cable cutter - Ratchet Spare blade

| Item Number | i | |
|-------------|--------|---|
| Z3677 1 | moving | 3 |
| Z3677 2 | fixed | 3 |

- Special alloy steel construction with razor sharp, induction hardened cutting edges for outstanding cutting performance
- Suitable for copper & aluminium wire only



Cable cutters

| Item Number | | ∅ | |
|-------------|--------------|------|---|
| T3963 | 210mm 8" | 11mm | 3 |
| T3963 240 | 240mm 9 1/2" | 13mm | 3 |

- Designed for fast and efficient cutting of aluminium & copper wires and plastic sheathed cables
- Stainless steel razor sharp shearing blades for outstanding cutting performance
- Spring assisted blade opening with safety closing catch for convenience
- PVC coated handles for comfort and grip



Cable snips

| Item Number | Length | Quantity |
|-------------|--------------|----------|
| 430008 | 165mm 6 1/2" | 3 |

- Heavy duty design for shearing soft cables, insulation materials, tape, cable ties and many other materials
- Micro serrated stainless steel blades, hollow ground for self sharpening, superior cutting performance
- Integrated cutting notch for effective cable & wire stripping
- Belt pouch for convenient storage



Electrician's scissors

| Item Number | Length | Quantity |
|-------------|-----------|----------|
| 492001 | 140mm 10" | 6 |

CABLE TIE GUNS

- Designed for automatic tensioning and trimming of cable ties
- Heavy duty stainless steel construction for outstanding long term performance
- Tension adjuster for the perfect tensioning of different widths of cable ties



Cable tie gun - Heavy duty

| Item Number | Length | Quantity |
|-------------|--------------|----------|
| 495004 | 4.7mm - 13mm | 10 |

- Designed for automatic tensioning and trimming of cable ties
- Tension adjuster for the perfect tensioning of different widths of cable ties



Cable tie gun

| Item Number | Length | Quantity |
|-------------|---------------|----------|
| 495003 | 2.4mm - 4.8mm | 6 |

DRAW TAPES

- Special flexible spring steel for outstanding strength & reliability
- Integral braking system for non-slip cable pull through



Electrician's draw tape cassette

| Item Number | Length | Quantity |
|-------------|--------------|----------|
| 495008 | 50ft / 15.2m | 1 |

- Lead spring guide for smooth feed & minimal snagging
- Special 'Perlon' tape for strength & reliability

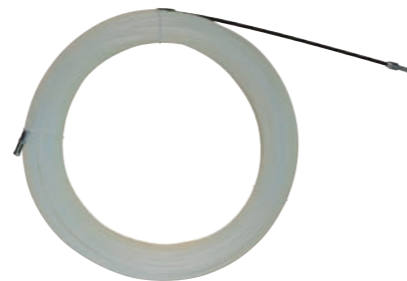

Electrician's draw tape

| Item Number | Length | Quantity |
|-------------|--------|----------|
| 495005 | 10m | 3 |
| 495006 | 20m | 3 |
| 495007 | 30m | 3 |

SWITCH KEYS

- PH2 screwdriver bit included



Switch key - Universal 9 in 1

| Item Number | Icons | Quantity |
|-------------|---------|----------|
| T4451-2 | [Icons] | 6 |

- Compact pen-style design offering 7 key types
- Tough glass reinforced nylon construction - strong & light weight
- Modulo size 2 screwdriver bit included



Switch key - Universal 7 in 1

| Item Number | Icons | Quantity |
|-------------|---------|----------|
| T4451-1 | [Icons] | 6 |

- 6mm bit driver adapter & double ended screwdriver bit included



Switch key - Universal 8 in 1

| Item Number | Icons | Quantity |
|-------------|---------|----------|
| 495015 | [Icons] | 10 |
| 495002 | [Icons] | 10 |

- High quality, heavy duty construction for professional use
- Long life tips suitable for use with lead free solder
- Individually tested to 10,000V for safe live working up to 1,000V



Soldering irons

CE, GS, ROHS 2002/95/EC, VDE0682/201, WEEE 2002/96/EC



| Item Number | Power | Plug Type | Quantity |
|-------------|-----------------------|-----------------|----------|
| 495009 | soldering iron 25W | UK 3-pin plug | 1 |
| 495010 | soldering iron 40W | UK 3-pin plug | 1 |
| 495011 | soldering iron 25W | Euro 2-pin plug | 1 |
| 495012 | soldering iron 40W | Euro 2-pin plug | 1 |
| 495013 | spare tip set for 25W | - | 1 |
| 495014 | spare tip set for 40W | - | 1 |

- For the fast and secure seating of data wires into terminals - suitable for a wide range of terminal block types
- One step action for automatic seating & trimming of excess wires
- Handle includes wire extractor hook & spudger



Punch down tool

| Item Number | Length | Quantity |
|-------------|----------|----------|
| 495033 | 180mm 7" | 3 |

- Precision ground, HSS tap for a clean, accurate cut & long life
- 50mm tap length for improved access
- Shatter resistant acetate handle for damage protection

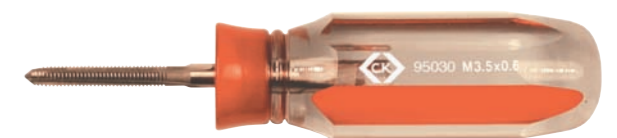

Re-threading tools

| Item Number | Thread | Length | Quantity |
|-------------|--------|--------|----------|
| 495028 | M3.5 | 0.6 | 12 |
| 495029 | M4 | 0.7 | 12 |

HAMMERSHÄMMER
MARTEAUX
MARTILLOS**60-63****WRECKING TOOLS**ABRISSWERKZEUGE
OUTILS DE DÉMOLITION
HERRAMIENTAS DE DEMOLICIÓN**63****CHISELS & BOLSTERS**MEißEL UND BREITEISEN
BURINS ET CISEAUX
CINCELES PARA MADERA Y MAMPOSTERÍA**64-65****PROFESSIONAL SOFT GRIP TROWELS**PROFESSIONELLE KELLEN MIT
WEICHEM GRIFF
TRUELLES PROFESSIONNELLES AVEC
POIGNÉE À REVÊTEMENT SOUPLE
PALETAS DE AGARRE SUAVE
PARA PROFESIONALES**66****TRADITIONAL HARD WOOD TROWELS**TRADITIONELLE HARTHOLZSPACHTELN
TRUELLES TRADITIONNELLES À POIGNÉE
EN BOIS DUR
PALETAS CON MANGO DE MADERA**66-67****STAINLESS STEEL TROWELS**EDELSTAHLKELLEN
TRUELLES EN ACIER INOXYDABLE
PALETAS DE ACERO INOXIDABLE**68****PLASTERING TOOLS**VERPUTZWERKZEUGE
OUTILS DE PLÂTRERIE
HERRAMIENTAS DE ENYESADO**68-69****PADDLE & MIXERS**SCHAUFEL UND MISCHER
MÉLANGEUR ET MALAXEURS
PALETAS Y MEZCLADORES**69****INSPECTION LAMPS**INSPEKTIONSLAMPEN
BALADEUSES
LÁMPARAS DE INSPECCIÓN**70****PLUMBING**KLEMPNERARBEITEN
PLOMBERIE
FONTANERÍA**70-71****TILING & GLAZING**FLIESENLEGEN UND VERGLASEN
CARRELAGE ET VITRAGE
AZULEJOS Y CRISTALES**72****SCRAPERS & FILLING KNIVES**SCHABER UND KROPFSPACHTEL
GRATTOIRS ET COUTEAUX À ENDUIRE
RASPADORES Y ESPÁTULAS PARA
RELLENADO**73****STAPLE GUNS**TACKER
AGRAFEUSES
PISTOLAS GRAPADORAS**74-75****GLUE GUNS**KLEBPISTOLEN
PISTOLETS À COLLE
PISTOLAS DE COLA**75**

BUILDING & PLUMBING

BAU UND SANITÄRINSTALLATION
BÂTIMENT ET PLOMBERIE
CONSTRUCCIÓN Y FONTANERÍA

ANTI-VIBRATION HAMMERS

ANTI-VIBRATIONS-HÄMMER

MARTEAUX ANTI-VIBRATIONS

MARTILLOS ANTIVIBRACIÓN



- 1 Single piece drop forged high carbon steel head & shaft - hardened & tempered for superior strength & durability**
Aus einem Stück gesenkgeschmiedeter Kopf und Stiel aus hochlegiertem Kohlenstoffstahl - gehärtet und angelassen für überragende Festigkeit und Dauerhaftigkeit
Tête et manche d'une seule pièce en acier à haute teneur en carbone matricé - trempé pour une résistance et une durabilité excellentes
Cabeza y mango forjados de acero de alto contenido de carbono en una sola pieza, endurecida y templada para mayor resistencia y durabilidad
- 2 Balanced weight design with energy saving claw geometry for improved performance**
Ausbalanciertes Gewicht mit Energie sparender Klauengeometrie für verbesserte Leistung
Conception assurant l'équilibrage des poids avec géométrie de panne fendue à économie d'énergie pour un meilleur rendement
Diseñados para obtener un peso equilibrado con geometría de orejas optimizada para el ahorro de tiempo y esfuerzo, mejorando así el rendimiento
- 3 Contoured anti-vibe shock absorbing grip system to protect against injury through shock**
Anti-Vibe Schock absorbierendes Dämpfungssystem, um Verletzungen beim Schlagen zu vermeiden
Système de préhension profilé anti-vibrations et antichocs pour protéger l'utilisateur des lésions occasionnées par les chocs
Sistema de amortiguado antivibración con agarre contorneado para evitar las lesiones al golpear
- 4 Polished & lacquered to protect against corrosion**
Poliert und lackiert zum Schutz gegen Korrosion
Finition polie et laquée pour la protection contre la corrosion
Pulidos y barnizados para proteger contra la corrosión



HAMMERS

- See adjoining feature page



Claw hammers - Anti-vibration one piece forged

| Item Number | | |
|-------------|-----------|---|
| 357001 | 454g 16oz | 6 |
| 357002 | 568g 20oz | 6 |

- Single piece drop forged high carbon steel head & shaft - hardened & tempered for superior strength and durability
- Contoured anti-vibe shock absorbing grip system to protect against injury from transmitted shock
- Polished and lacquered to protect against corrosion



Club hammer - Anti-vibration one piece forged

| Item Number | | |
|-------------|-----------|---|
| 357005 | 1361g 3lb | 2 |

- Drop forged high carbon steel head - hardened & tempered for superior strength and durability
- Tough fibreglass shaft for strength
- Contoured anti-vibe shock absorbing grip system to protect against injury from transmitted shock
- Polished and lacquered to protect against corrosion



Claw hammers - Anti-vibration fibreglass shaft

| Item Number | | |
|-------------|-----------|---|
| 357003 | 454g 16oz | 6 |
| 357004 | 568g 20oz | 6 |

- Drop forged high carbon steel head - hardened & tempered for superior strength and durability
- Tubular steel shaft - strong & lightweight
- Hi-vis handle for increased visibility in low light conditions
- Black lacquered to protect against corrosion



Claw hammers - Hi-vis

| Item Number | | |
|-------------|-----------|---|
| T4229 08 | 227g 8oz | 6 |
| T4229 16 | 454g 16oz | 6 |
| T4229 20 | 568g 20oz | 6 |

- Drop forged high carbon steel head - hardened & tempered for superior strength and durability
- Black lacquered to protect against corrosion
- Tough hickory shaft to withstand high impact applications



Club hammers

| Item Number | | |
|-------------|------------|---|
| T4219 40 | 1135g 2½lb | 2 |
| T4219 64 | 1816g 4lb | 2 |

- Drop forged high carbon steel head - hardened & tempered for superior strength and durability
- Black lacquered to protect against corrosion
- Traditional ash shaft



Club hammers - German pattern

| Item Number | | |
|-------------|------------|---|
| T4219A 10 | 1000g 2¼lb | 6 |
| T4219A 15 | 1500g 3½lb | 6 |

- Drop forged high carbon steel head - hardened & tempered for superior strength and durability
- Vibration damping fibreglass shaft for strength & protection
- Rubber overstrike collar protects against damage & transmitted shock



Sledge hammers

| Item Number | Weight | Quantity |
|-------------|-------------|----------|
| T421808 | 3.63kg 8lb | 2 |
| T421812 | 5.44kg 12lb | 2 |

- Drop forged high carbon steel head - hardened & tempered for superior strength and durability
- Accurately ground chisel end for clean cutting
- Tubular steel shaft - strong & lightweight



Brick hammers

| Item Number | Weight | Quantity |
|-------------|-----------|----------|
| T4232 16 | 454g 16oz | 4 |
| T4232 20 | 568g 20oz | 4 |

- Drop forged high carbon steel head - hardened & tempered for superior strength and durability
- Tubular steel shaft - strong & lightweight



Mortar pick

| Item Number | Description | Quantity |
|-------------|------------------|----------|
| T4234 | chisel and point | 6 |

- Drop forged high carbon steel head - hardened & tempered for superior strength and durability
- Black lacquered to protect against corrosion
- Tough hickory shaft for durability
- Cross pein for easy starting of small nails & pins



Pin hammer

| Item Number | Weight | Quantity |
|-------------|----------|----------|
| T4203 | 114g 4oz | 3 |

- Drop forged high carbon steel head - hardened & tempered for superior strength and durability
- Black lacquered to protect against corrosion
- Tough hickory shaft for durability
- Cross pein for easy starting of small nails & pins



Joiner's hammers

| Item Number | Weight | Quantity |
|-------------|-----------|----------|
| T4204 06 | 171g 6oz | 3 |
| T4204 08 | 227g 8oz | 3 |
| T4204 10 | 284g 10oz | 3 |

- Drop forged high carbon steel head - hardened & tempered for superior strength and durability
- Black lacquered to protect against corrosion
- Tough hickory shaft for durability
- Ball pein for setting rivets



Ball pein hammers

| Item Number | Weight | Quantity |
|-------------|--------------|----------|
| T4208H 08 | 227g 1/2lb | 3 |
| T4208H 16 | 454g 1lb | 3 |
| T4208H 24 | 682g 1 1/2lb | 3 |
| T4208H 32 | 908g 2lb | 3 |

- Drop forged high carbon steel head - hardened & tempered for superior strength and durability
- Black lacquered to protect against corrosion
- Traditional ash shaft for strength



Electrician's hammer - French pattern

| Item Number | Weight | Quantity |
|-------------|----------|----------|
| 356001 | 200g 7oz | 12 |

- Drop forged high carbon steel head - hardened & tempered for superior strength and durability
- Black lacquered to protect against corrosion
- Traditional ash shaft for strength



Engineer's hammer - French pattern

| Item Number | Weight | Quantity |
|-------------|----------------|----------|
| 356002 | 300g 10 1/2 oz | 12 |

- Drop forged high carbon steel head - hardened & tempered for superior strength and durability
- Black lacquered to protect against corrosion
- Traditional ash shaft for strength



Engineer's hammers - German pattern

DIN 1041

| Item Number | Weight | Quantity |
|-------------|----------------|----------|
| T4227A 0100 | 100g 3 1/2 oz | 12 |
| T4227A 0200 | 200g 7oz | 12 |
| T4227A 0300 | 300g 10 1/2 oz | 12 |
| T4227A 0500 | 500g 17 1/2 oz | 12 |
| T4227A 1000 | 1000g 35oz | 6 |

WRECKING TOOLS

- Forged spring steel for strength and durability
- Specially contoured & notched for efficient nail pulling and prying
- Sharp angle ground ends for effective chiseling & scraping



Prybar, nail puller & scraper

| Item Number | Length | Quantity |
|-------------|-----------|----------|
| T4310 | 380mm 15" | 6 |

- High grain carbon steel, hardened and tempered for strength and durability
- Chisel end & goose neck end with nail pulling notch ideal for heavy duty levering and dismantling work



Wrecking bars

| Item Number | Length | Quantity |
|-------------|-----------|----------|
| T431418 | 455mm 18" | 1 |
| T431424 | 610mm 24" | 1 |

- Single piece forged spring steel construction for strength & durability
- Slim blade design with double sided hooked blades for fast & effective nail cutting



Slater's ripper

| Item Number | Quantity |
|-------------|----------|
| T5180 | 1 |

CHISELS & BOLSTERS

- Hand guard for increased comfort & protection from overstrike



Brick bolsters - With grip

BS 3066

| Item Number | Length | Head Width | Quantity |
|-------------|----------|------------|----------|
| T3087S 3 | 230mm 9" | 75mm 3" | 10 |
| T3087S 4 | 230mm 9" | 100mm 4" | 10 |



Brick bolsters

BS 3066

| Item Number | Length | Head Width | Quantity |
|-------------|----------|------------|----------|
| T3087 3 | 230mm 9" | 75mm 3" | 10 |
| T3087 4 | 230mm 9" | 100mm 4" | 10 |

- Hand guard for increased comfort & protection from overstrike



Electrician's bolster - With grip

BS 3066

| Item Number | Length | Head Width | Quantity |
|-------------|--------------|-------------|----------|
| T3086S | 225mm 8 3/4" | 55mm 2 1/4" | 10 |



Electrician's bolster

BS 3066

| Item Number | Length | Head Width | Quantity |
|-------------|--------------|-------------|----------|
| T3086 | 225mm 8 3/4" | 55mm 2 1/4" | 10 |

- Angled & grooved cutting edge for the effective removal of mortar & cement



Plugging chisel

BS 3066

| Item Number | Length | Head Width | Quantity |
|-------------|-----------|------------|----------|
| T3088 | 250mm 10" | 25mm 1" | 10 |

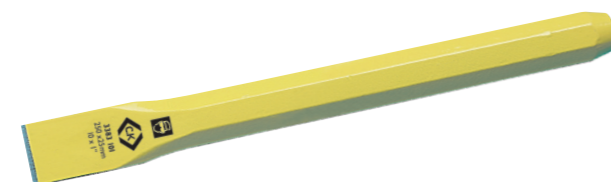

Cold chisels

BS 3066

| Item Number | Length | Head Width | Quantity |
|-------------|-----------|------------|----------|
| T3383 06 | 150mm 6" | 12mm 1/2" | 10 |
| T3383 07 | 180mm 7" | 16mm 5/8" | 10 |
| T3383 08 | 200mm 8" | 19mm 3/4" | 10 |
| T3383 10 | 250mm 10" | 19mm 3/4" | 10 |
| T3383 101 | 250mm 10" | 25mm 1" | 10 |
| T3383 12 | 300mm 12" | 25mm 1" | 10 |
| T3383 18 | 460mm 18" | 19mm 3/4" | 10 |

- High quality carbon steel, hardened & tempered for strength & durability
- Replaceable chisel bits



Scutch chisel

BS 3066

| Item Number | Head Width | Quantity |
|-------------|-------------|----------|
| 406001 | 25mm 1" | 3 |
| 406002 | 38mm 1 1/2" | 3 |

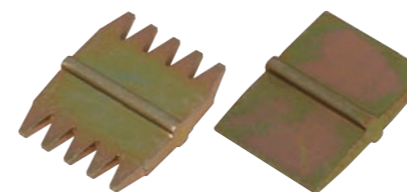

Scutch chisel - Spare bits

| Item Number | Head Width | Bit Type | Quantity |
|-------------|-------------|---------------|----------|
| T4211/1 | 25mm 1" | scutch combs | 10 |
| T4211/2 | 25mm 1" | scutch droves | 10 |
| T4211/3 | 38mm 1 1/2" | scutch combs | 10 |
| T4211/4 | 38mm 1 1/2" | scutch droves | 10 |

CONTENTS: 7 x plugging chisels. 7 x electrician's bolster chisels. 6 x bolster chisels, sizes: 75 & 100mm. 3 x bolster chisels with grip, size: 100mm.



Bolster chisels display

BS 3066

| Item Number | Description | Quantity |
|-------------|-----------------|----------|
| T3090LS | stock and stand | 1 |

CONTENTS: 8 x cold chisels, size: 12 x 150mm. 7 x cold chisels, size: 16 x 180mm. 6 x cold chisels, sizes: 19 x 200 & 19 x 250mm. 5 x cold chisels, sizes: 25 x 250 & 25 x 300mm.



Cold chisels display

BS 3066

| Item Number | Description | Quantity |
|-------------|-----------------|----------|
| T3389LS | stock and stand | 1 |

PROFESSIONAL SOFT GRIP TROWELS

- High carbon steel blade, hardened & taper ground for the optimum balance of strength & flexibility
- Heavy duty tang welded to blade for strength & durability
- Patented soft grip handle with finger guard for comfort & control



Brick trowel - Broad heel

| Item Number | Length | Quantity |
|-------------|-----------|----------|
| T529510 | 255mm 10" | 3 |



Brick trowel - Philadelphia

| Item Number | Length | Quantity |
|-------------|-----------|----------|
| T529311 | 280mm 11" | 3 |



Pointing trowel

| Item Number | Length | Quantity |
|-------------|----------|----------|
| T529606 | 150mm 6" | 3 |



Gauging trowel

| Item Number | Length | Quantity |
|-------------|----------|----------|
| T529207 | 180mm 7" | 6 |



Finger trowel

| Item Number | Length | Quantity |
|-------------|----------------------|----------|
| T529750 | 175 x 13mm 7" x 1/2" | 3 |

TRADITIONAL HARD WOOD TROWELS

- High carbon steel blade, hardened & taper ground for the optimum balance of strength & flexibility
- Heavy duty tang welded to blade for strength & durability
- Traditional wooden handle



Brick trowel - Broad heel

| Item Number | Length | Quantity |
|-------------|-----------|----------|
| T527010 | 250mm 10" | 6 |
| T527011 | 275mm 11" | 3 |



Brick trowel - Philadelphia

| Item Number | Length | Quantity |
|-------------|-----------|----------|
| T527111 | 275mm 11" | 1 |



Pointing trowels

| Item Number | Length | Quantity |
|-------------|----------|----------|
| T5060 4 | 100mm 4" | 3 |
| T5060 5 | 125mm 5" | 3 |
| T5060 6 | 150mm 6" | 6 |



Gauging trowel

| Item Number | Length | Quantity |
|-------------|----------|----------|
| T527207 | 175mm 7" | 3 |

- T5073 1 with half round blade



Finger trowels

| Item Number | Length | Blade Width | Quantity |
|-------------|----------|-------------|----------|
| T5073 37 | 175mm 7" | 10mm 3/8" | 3 |
| T5073 50 | 175mm 7" | 13mm 1/2" | 3 |
| T5073 62 | 175mm 7" | 16mm 5/8" | 3 |
| T5073 75 | 175mm 7" | 19mm 3/4" | 3 |
| T5073 99 | 175mm 7" | 25mm 1" | 3 |
| T5073 1 | 175mm 7" | 13mm 1/2" | 3 |



Margin trowel

| Item Number | Length | Quantity |
|-------------|----------|----------|
| T5273 | 125mm 5" | 3 |

- Welded & riveted tang to blade joint for outstanding durability



Flooring trowel

| Item Number | Length | Quantity |
|-------------|-------------------------|----------|
| T5264 | 405 x 115mm 16 x 4 1/2" | 3 |

- Heavy duty carbon steel blade for strength
- 6 rivet blade joint for durability



Edging trowel

| Item Number | Length | Quantity |
|-------------|-------------------------|----------|
| T5274 | 280 x 115mm 11 x 4 1/2" | 3 |

- Heavy gauge steel blade with tang welded to blade for strength & durability



Harling trowel

| Item Number | Length | Quantity |
|-------------|----------------------------|----------|
| T5097 | 165 x 165mm 6 1/2 x 6 1/2" | 2 |

STAINLESS STEEL TROWELS

- Stainless steel blade for corrosion protection & low maintenance
- Heavy duty tang welded to blade for strength & durability
- Patented soft grip handle with finger guard for comfort & control



Brick trowel - Philadelphia

| Item Number | Length | Quantity |
|-------------|-----------|----------|
| T524111 | 280mm 11" | 3 |

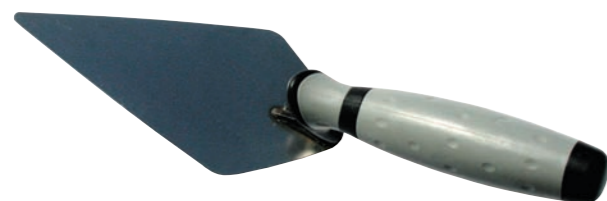

Pointing trowel

| Item Number | Length | Quantity |
|-------------|----------|----------|
| T524306 | 150mm 6" | 6 |

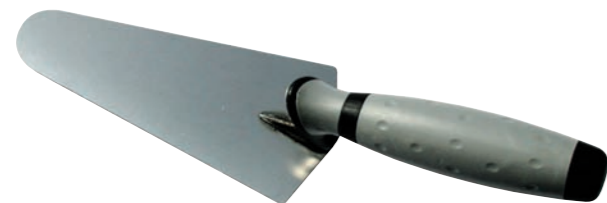

Gauging trowel

| Item Number | Length | Quantity |
|-------------|----------|----------|
| T524207 | 175mm 7" | 3 |

- Fully hardened & tempered carbon steel for wear resistance



Brick jointer

| Item Number | Dimensions | Quantity |
|-------------|----------------------|----------|
| T5198 | 13 x 16mm 1/2 x 5/8" | 12 |

PLASTERING TOOLS

- High carbon steel blade, hardened & tempered for the optimum balance of strength & flexibility
- Welded & riveted tang to blade joint for outstanding durability
- Soft grip handle for comfort & control



Plasterer's trowel - Steel, soft grip

| Item Number | Dimensions | Quantity |
|-------------|-------------------------|----------|
| T5298 | 280 x 120mm 11 x 4 3/4" | 6 |

- High carbon steel blade, hardened & tempered for the optimum balance of strength & flexibility
- Welded & riveted tang to blade joint for outstanding durability
- Traditional wooden handle



Plasterer's trowel - Steel

| Item Number | Dimensions | Quantity |
|-------------|-------------------------|----------|
| T5068 | 280 x 120mm 11 x 4 3/4" | 6 |

- Stainless steel blade for corrosion protection & low maintenance
- Welded & riveted tang to blade joint for outstanding durability
- Traditional wooden handle



Plasterer's trowel - Stainless steel

| Item Number | Dimensions | Quantity |
|-------------|-------------------------|----------|
| T5072 | 280 x 120mm 11 x 4 3/4" | 6 |

- Stainless steel blade for corrosion protection & low maintenance
- Welded & riveted tang to blade joint for outstanding durability
- Traditional wooden handle



Plasterer's trowel - Stainless steel, large

| Item Number | Dimensions | Quantity |
|-------------|-------------------------|----------|
| T5299 | 330 x 120mm 13 x 4 3/4" | 6 |

- Lightweight aluminium blade with grooved, non-slip surface

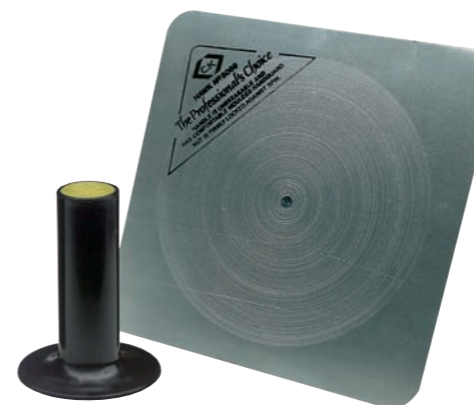

Plasterer's hawk

| Item Number | Dimensions | Quantity |
|-------------|----------------------|----------|
| T5069 | 300 x 300mm 12 x 12" | 3 |

- Lightweight, moulded foam polymer with fine chequered working face - durable & non-warping



Skimmer floats

| Item Number | Dimensions | Quantity |
|-------------|-------------|----------|
| T5172 | 280 x 140mm | 1 |
| T5172 18 | 320 x 180mm | 1 |

- Solid forged steel blade, hardened, tempered & ground for the optimum balance of flexibility & strength



Trowel & square tools

| Item Number | Length | Blade Width | Quantity |
|-------------|---------------|-------------|----------|
| T5093 50 | 265mm 10 1/2" | 12mm 1/2" | 3 |
| T5093 62 | 265mm 10 1/2" | 16mm 5/8" | 3 |
| T5093 75 | 265mm 10 1/2" | 19mm 3/4" | 3 |

- Solid forged steel blade, hardened, tempered & ground for the optimum balance of flexibility & strength



Leaf & square tool

| Item Number | Length | Blade Width | Quantity |
|-------------|----------|-------------|----------|
| T5091 50 | 200mm 8" | 12mm 1/2" | 3 |

PADDLE & MIXERS

- Steel & cast aluminium construction - strong & light weight



Plasterer's paddle

| Item Number | Length | Quantity |
|-------------|-----------|----------|
| T1885 | 790mm 31" | 1 |

- Nickel plated steel construction for strength & easy cleaning
- Suitable for use with electric drills at speeds between 200 - 700 rpm



Drill mixers

| Item Number | Length | Quantity |
|-------------|---------------|----------|
| T1881 | 420mm 16 1/2" | 2 |
| T1882 | 620mm 25" | 2 |

INSPECTION LAMPS

- Heavy duty steel cage & glass for damage protection
- Suspension hook for convenience
- 5m cable for long reach access
- Max 60W 240V screw-in bulb (not included)



Inspection lamps

CE, ROHS 2002/95/EC, WEEE 2002/96/EC

| Item Number | | | |
|-------------|-----------------|---|--|
| T5901 | U.K 3-pin plug | 1 | |
| T5901A | Euro 2-pin plug | 1 | |

- Sealed 240V 8W fluorescent lamp with suspension hook for convenience
- 5m cable for long reach access



Inspection lights

CE, ROHS 2002/95/EC, WEEE 2002/96/EC

| Item Number | | | |
|-------------|-----------------|---|--|
| T5902 | U.K 3-pin plug | 2 | |
| T5902A | Euro 2-pin plug | 2 | |

PLUMBING

- Black lacquered die cast aluminium for strength & corrosion resistance
- Integral de-burring blade in the handle for convenience
- Replaceable hardened steel cutting wheel effortlessly cuts copper, brass, aluminium, and thin wall steel pipe
- With spare cutting wheel



Pipe cutter - 3-30mm

| Item Number | | | |
|-------------|----------|---|--|
| T2231 | 3 - 30mm | 5 | |

- Black lacquered die cast aluminium for strength & corrosion resistance
- Replaceable hardened steel cutting wheel effortlessly cuts copper, brass, aluminium, and thin wall steel pipe

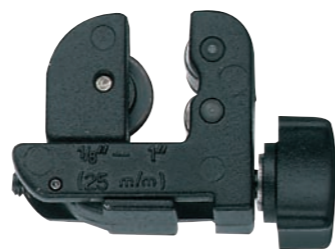

Pipe cutter - 3-25mm

| Item Number | | | |
|-------------|----------|----|--|
| T2232 | 3 - 25mm | 10 | |

- Suitable for T2231 & T2232 Pipe Cutters

Pipe cutter - Spare wheel

| Item Number | | | |
|-------------|--------|----|--|
| T2235 | 19.5mm | 10 | |

- Adjustable, telescopic wrench with sliding T handle for confined & long reach access
- Spring loaded, self adjusting jaws maintain an automatic grip
- 180° swivelling head for clockwise or anti-clockwise action
- Hardened steel jaws for durability



Basin wrench

| Item Number | | | |
|-------------|-------------|---|--|
| T4311 | 275 - 460mm | 6 | |

- One piece steel construction for strength & durability
- Zinc plated for corrosion protection
- PVC handle for comfort and grip

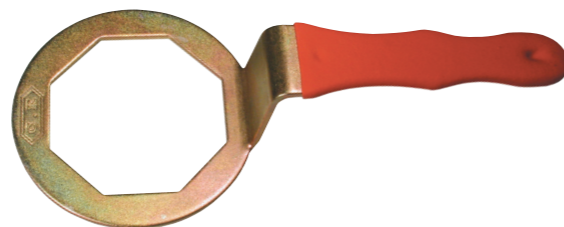

Immersion heater spanner

| Item Number | | | |
|-------------|------|---|--|
| T4347 | 85mm | 6 | |

- Heavy duty aluminium body - strong & light
- Ratchet action razor sharp stainless steel blade for effortless cutting of; PVC conduit, blue water mains, plastic pipe, rubber hose, pneumatic pipe, electrical sleeving, etc.
- Complete with special adaptor for straight or mitre cutting of small rectangular cross-section trunking



PVC pipe & conduit cutter - Ratchet

| Item Number | | | |
|-------------|-------|------|---|
| 430003 | 220mm | 32mm | 3 |

- Heavy duty aluminium body - Strong & light
- Lever action razor sharp stainless steel blade for effortless cutting of; PVC conduit, blue water mains, plastic pipe, rubber hose, pneumatic pipe, electrical sleeving, wooden dowel, etc
- 5 interchangeable anvils (flat, double radius, single radius, 90° square and mitre) allow a variety of cross sections to be cut, both straight and mitred



Multi cutter set

| Item Number | | | |
|-------------|--|--|---|
| T2240 | | | 3 |

- Glass fibre reinforced polycarbonate body - strong & light
- Razor sharp stainless steel blade for efficient cutting of: PVC conduit, blue water mains, plastic pipe, rubber hose, pneumatic pipe, electrical sleeving, etc.



PVC pipe & conduit cutter

| Item Number | | | |
|-------------|-------|------|---|
| 430001 | 195mm | 28mm | 3 |

- High quality drop forged steel construction with hardened & tempered jaws for strength & durability
- Patented head design for high torque performance



Stillson wrenches

| Item Number | | | |
|-------------|-----------|------|---|
| T3735 300 | 300mm 12" | 38mm | 8 |
| T3735 350 | 350mm 14" | 55mm | 8 |
| T3735 450 | 450mm 18" | 55mm | 8 |
| T3735 600 | 600mm 24" | 70mm | 4 |

- High quality drop forged steel construction, hardened & tempered for strength & durability



Plumbing spanner - Double ended

DIN 895

| Item Number | | | |
|-------------|-------|-----------|---|
| T4381 | 255mm | 24 x 32mm | 3 |

- High quality drop forged steel construction, hardened & tempered for strength & durability



Plumbing spanner - Single ended

DIN 894

| Item Number | | | |
|-------------|-------|------|---|
| T4382 039 | 300mm | 39mm | 3 |

TILING & GLAZING

- Tungsten carbide tipped, suitable for tiles, metal and glass
- Pocket clip



Tile scribe

| Item Number | |
|-------------|----|
| T1531 | 12 |

- Polished carbon steel blade with welded ergonomic handle for comfort & control



Adhesive trowels

| Item Number | 255 x 115mm 10 3/4 x 4 1/2" | 6mm 1/4" | 10 |
|-------------|-----------------------------|-----------|----|
| T5169 1 | | | |
| T5169 2 | | 20mm 3/4" | 10 |

- Lightweight, polymer handle bonded to a dense rubber pad - suitable for grout application



Grouting float

| Item Number | 280 x 140mm 11 x 5 1/2" | 1 |
|-------------|-------------------------|---|
| T5174 | | |

- Lightweight, polymer handle bonded to a sponge pad - suitable for washing down grout



Grouting sponge

| Item Number | 280 x 140mm 11 x 5 1/2" | 1 |
|-------------|-------------------------|---|
| T5173 | | |

- High quality with 6 premium quality tungsten carbide blades in turret head
- Oiled felt washer for constant lubrication



Glass cutter

| Item Number | 6 |
|-------------|---|
| T5087 | |

Spare blades

| Item Number | x 12 | 1 |
|-------------|------|---|
| T5089 | | |

- High quality spring steel blade for strength & flexibility
- Clip point profile for smoothing & shaping putty
- Rosewood handle



Putty knife

| Item Number | 1 |
|-------------|---|
| T5076 | |

- Lever action, double suction cup designed to lift up to 60kg

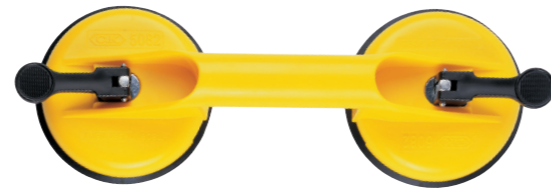

Suction lifter - 60kg

| Item Number | 320mm 12 5/8" | 60kg | 1 |
|-------------|---------------|------|---|
| T5082 | | | |

- Clamp action suction cup designed to lift up to 30kg



Suction lifter - 30kg

| Item Number | 120mm 4 3/4" | 30kg | 1 |
|-------------|--------------|------|---|
| T5081 | | | |

SCRAPERS & FILLING KNIVES

- High quality, tapered ground spring steel blade for strength
- Rosewood handle



Scrapers

| Item Number | 25mm 1" | 3 |
|-------------|----------|---|
| T5075 1 | | |
| T5075 2 | 50mm 2" | 3 |
| T5075 3 | 75mm 3" | 3 |
| T5075 4 | 100mm 4" | 3 |

- High quality, thin, tapered ground spring steel blade for the optimum balance of strength & flexibility required for filling
- Rosewood handle



Filling knife

| Item Number | 75mm 3" | 6 |
|-------------|---------|---|
| T5077 3 | | |

- Tapered ground spring steel blade for strength & flexibility
- Plastic wipe clean handles with hanging hole for convenient storage



Scraper / filling knives

| Item Number | 40mm 1 1/2" | 6 |
|-------------|-------------|---|
| T5070A 040 | | |
| T5070A 050 | 50mm 2" | 6 |
| T5070A 070 | 70mm 2 3/4" | 6 |
| T5070A 100 | 100mm 4" | 6 |

CONTENTS: 6 x sizes: 40, 50, 70 & 100mm.



Scraper / filling knife display stand

| Item Number | stock and stand | 1 |
|-------------|-----------------|---|
| T5070A/4LS | | |

- Super flexible spring steel construction designed for removing paint from glass, filling, etc.
- Fitted with plastic hand guards for safety



Scraper set - 4 Piece superflex

| Item Number | 50, 80, 100 and 120mm | 1 |
|-------------|-----------------------|---|
| T5064 | | |

STAPLE GUNS

- Heavy duty, tough cast aluminium body for strength & durability
- Bi-material ergonomic handle for comfort & reduced fatigue
- Unique staple loading & clearing mechanism for fast & convenient use
- Handle safety locking system prevents accidental operation

- Fires staples 6-14mm (interchangeable with Arrow T50 or Rapid 140 6-14mm) & nails (brads) 18 gauge 16mm
- Supplied with 200 x 8mm staples



Staple & nail gun

| Item Number | | |
|-------------|--|---|
| 496001 | | 3 |

- Fires half round staples for use on low voltage cable max 7.5mm diameter (interchangeable with Arrow T25).



Cable tacker - Low voltage cable

| Item Number | | |
|-------------|-------|---|
| T6227 | 7.5mm | 3 |

- Fires half round staples for use on telecom data cable max 4.8mm diameter



Cable tacker - Telecom cable

| Item Number | | |
|-------------|-------|---|
| T6228 | 4.8mm | 3 |

- High quality steel cable staples, galvanised for corrosion protection - to suit C.K T6227 cable tacker

Cable staples - Half round

| Item Number | | |
|-------------|------------|----|
| 495021 | 7.5 x 10mm | 10 |
| 495022 | 7.5 x 14mm | 10 |

- High quality steel staples, galvanised for corrosion protection - to suit C.K 496001 heavy duty staple gun

Staples - Square

| Item Number | | |
|-------------|-------------|----|
| 496002 | 10.5 x 8mm | 10 |
| 496003 | 10.5 x 10mm | 10 |
| 496004 | 10.5 x 12mm | 10 |
| 496005 | 10.5 x 14mm | 10 |

- High quality telecom cable staples, galvanised for corrosion protection
- White coated tops for discreet fixing - to suit C.K T6228 Telecom cable tacker

Telecom staples - Half round

| Item Number | | |
|-------------|------------|----|
| 495024 | 4.8 x 10mm | 10 |

CONTENTS: 4 x Staple & nail guns. 3 x boxes of square staples, sizes: 8, 10, 12 & 14mm.



Stapler display

| Item Number | | |
|-------------|-----------------|---|
| T6222-LS | stock and stand | 1 |

CONTENTS: 2 x Low voltage cable tacker. 2 x telecom cable tacker. 3 x boxes of half round cable staples, sizes: 10 & 14mm. 7 x boxes of half round telecom staples, size: 10mm.



Cable tacker display

| Item Number | | |
|-------------|-----------------|---|
| T6224-LS | stock and stand | 1 |

GLUE GUNS

- Premium quality with high energy heater for fast heating & improved glue flow
- Heat insulated nozzle for safety
- Glue output of up to 21g/min for fast application
- Supplied with two 100x11mm general purpose glue sticks



Glue gun

CE, ROHS 2002/95/EC, WEEE 2002/96/EC

| Item Number | | |
|-------------|-----------------|---|
| T6215 | UK 3 pin plug | 6 |
| T6215A | Euro 2 pin plug | 6 |

CONTENTS: Glue gun. 12 x glue sticks, size: 200mm. Carry case.



Glue gun kit

CE, ROHS 2002/95/EC, WEEE 2002/96/EC

| Item Number | | |
|-------------|-----------------|---|
| T6216 | Euro 2 pin plug | 1 |

Glue sticks

| Item Number | | | |
|-------------|-------|-------|---|
| T6218 06 | 100mm | x 6 | 6 |
| T6218 25 | 100mm | x 25 | 6 |
| T6219 025 | 200mm | x 25 | 1 |
| T6219 125 | 200mm | x 125 | 1 |

GEL-GRIP

GEL-GRIP
GEL-GRIP
GEL-GRIP

78-80

TAPE MEASURES

BANDMAßE
MÈTRES À RUBAN
CINTAS MÉTRICAS

81

RULES

LINEALE
RÈGLES
REGLAS

82

SPIRIT LEVELS

WASSERWAAGEN
NIVEAUX À BULLE
NIVELES

83

CHALK, LINES & ACCESSORIES

KREIDE, SCHNÜRE UND ZUBEHÖR
CRAIE, CORDEAUX ET ACCESSOIRES
TIZA, LÍNEAS Y ACCESORIOS

83

JOINER'S SQUARES & BEVELS

SCHREINER-WINKEL UND -SCHMIEGEN
ÉQUERRES DE MENUISIER ET FAUSSES-ÉQUERRES
ESCUADRAS DE CARPINTERO Y TRANSPORTADORES DE ÁNGULOS

84

COMBINATION SQUARES

KOMBINATIONSWINKEL
ÉQUERRES COMBINÉES
ESCUADRAS UNIVERSALES

85

VERNIER CALIPER

MESSSCHIEBER
PIED À COULISSE
CALIBRADOR VERNIER

85

FEELER GAUGE

FÜHLERLEHREN
JAUGES D'ÉPAISSEUR
GALGAS

85

POCKET BALANCE

FEDERZUGWAAGE
BALANCES DE POCHE
BÁSCULAS DE BOLSILLO

85

MEASURING & MARKING

MESSEN & MARKIEREN
MESURE & MARQUAGE
MEDICIÓN Y MARCADO

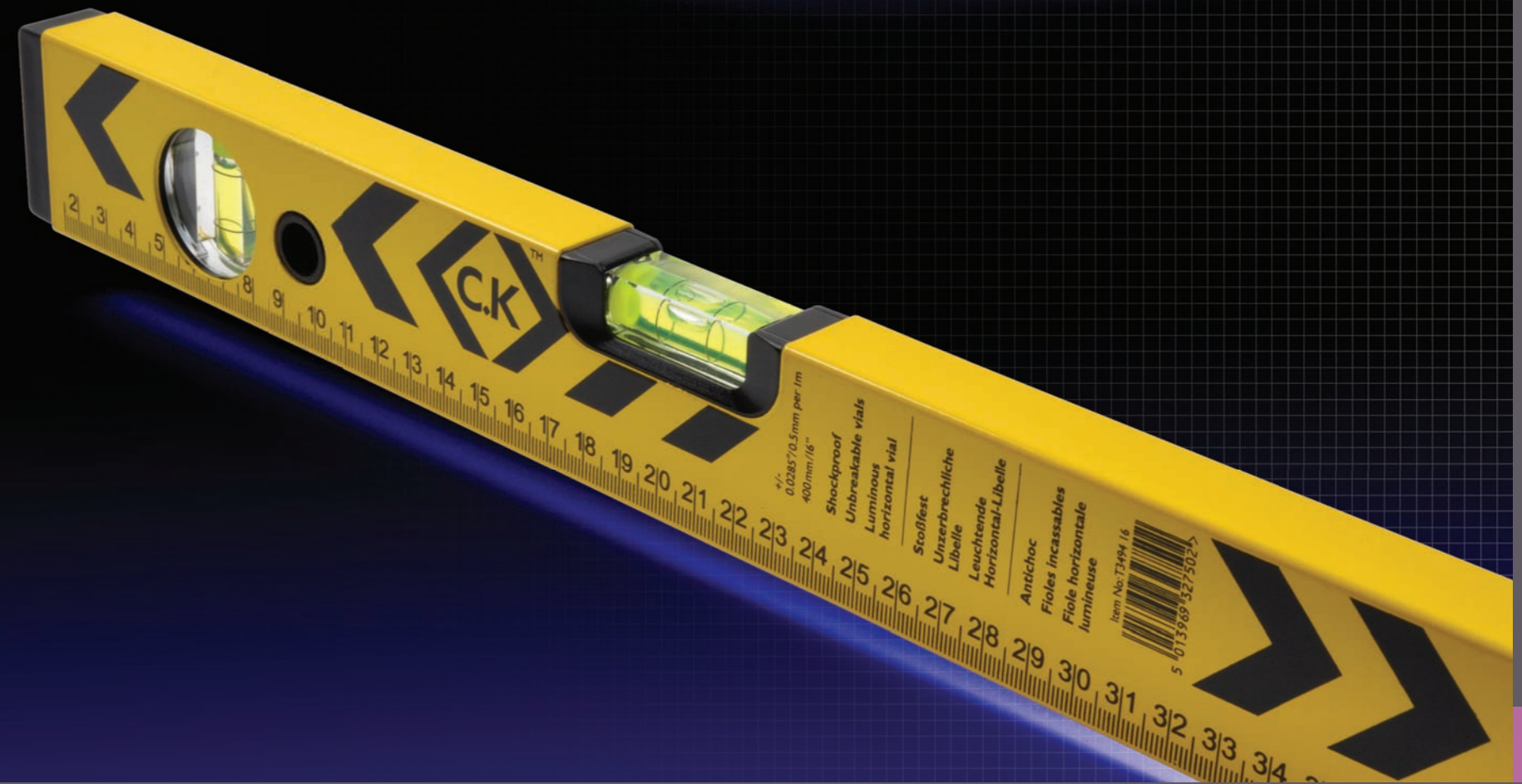
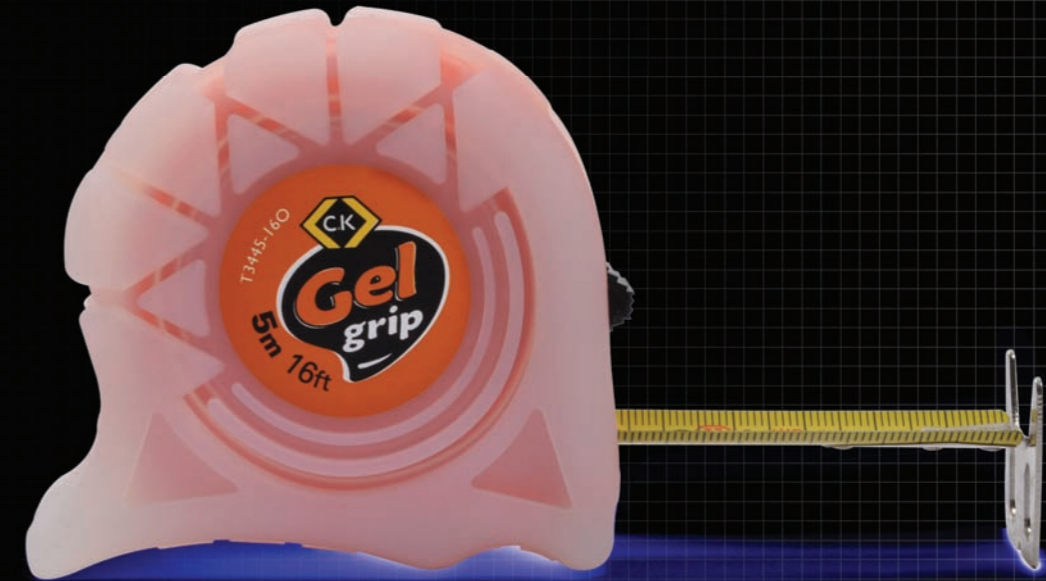

GEL-GRIP

ADVANCED TAPE TECHNOLOGY

FORTSCHRITTLICHE TECHNIK
MÈTRES À RUBAN TECHNOLOGIQUEMENT ÉVOLUÉS
TECNOLOGÍA AVANZADA DE CINTAS



1 Gel-grip jacket provides exceptional comfort with outstanding damage protection

Gel-grip Gehäuse bietet außergewöhnlichen Komfort mit überragendem Beschädigungsschutz
Corps en gel procure un confort exceptionnel avec une protection remarquable contre les chocs
La carcasa Gel-grip proporciona un confort excepcional con protección excelente contra daños

2 Specially designed end hook grips on the top, bottom & side

Speziell entworfener Endhaken greift oben, unten und seitlich
Crochet d'extrémité spécialement conçu s'accroche sur le dessus, au-dessous et sur le côté
Cuenta con gancho especialmente diseñado para enganchar por la parte superior, inferior y lateral

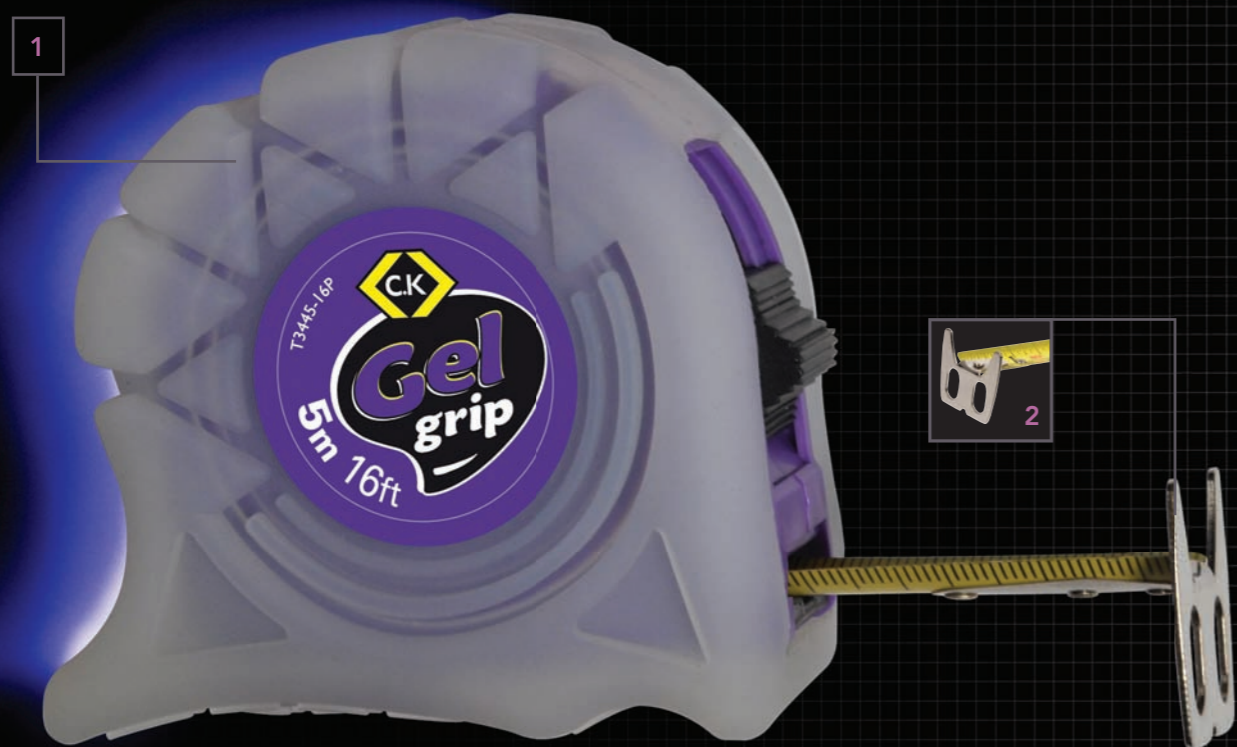

OVERHEAD MEASURING

ÜBERKOPF MESSEN
MESURAGE EN SURPLOMB
MEDICIÓN ELEVADA



VERTICAL MEASURING

VERTIKAL MESSEN
MESURAGE VERTICAL
MEDICIÓN VERTICAL



SIDE MEASURING

SEITLICH MESSEN
MESURAGE SUR LE CÔTÉ
MEDICIÓN LATERAL



DEVELOPED SPECIFICALLY FOR THE PROFESSIONAL TRADESMAN, THE C.K GEL-GRIP TAPE ENCOMPASSES THE VERY LATEST IN TAPE TECHNOLOGY

SPEZIFISCH FÜR DEN FACHMANN ENTWICKELT, UMFASST C.K GEL-GRIP DIE NEUESTEN TECHNOLOGIEN

SPÉCIFIQUEMENT ÉLABORÉ POUR LES UTILISATEURS PROFESSIONNELS, LE MÈTRE À RUBAN C.K GEL-GRIP INTÈGRE LES TOUTES DERNIÈRES ÉVOLUTIONS DE LA TECHNOLOGIE DES MÈTRES À RUBAN

DESARROLLADA ESPECÍFICAMENTE PARA LOS PROFESIONALES DEL SECTOR, LA CINTA C.K GEL-GRIP INCLUYE LO ÚLTIMO EN LA TECNOLOGÍA DE FLEXÓMETROS

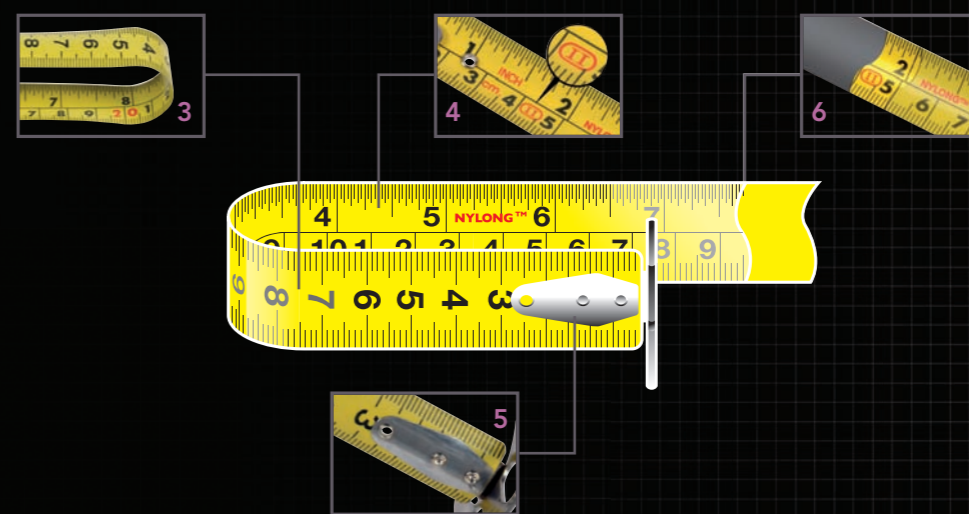

3 Double sided marking for regular, overhead & vertical measuring

Doppelseitige Markierung für normales, horizontal überkopf und vertikales Messen
Marquage sur les deux faces pour les relevés de cotes classiques, en surplomb et verticaux
Marcado en ambos lados para conseguir mediciones normales, elevadas y verticales

4 EC Class II for greater measuring accuracy (accurate to 1mm over 3m)

EC Klasse II für höhere Messgenauigkeit (1 mm über 3 m)
CE classe II pour une plus grande exactitude de mesurage (précision de 1 mm sur 3 m)
EC Clase II para una mayor exactitud de medición (precisión en 3m de 1 mm)

5 Triple riveted hook prevents blade & hook damage on rewind

Dreifach vernieteter Haken vermeidet Band- und Hakenbeschädigungen beim Zurückspulen
Le triple rivetage du crochet empêche toute détérioration au rembobinage
El gancho con triple remachado previene el daño producido en hoja y gancho durante el rebobinado

6 NYLON™ coated blade for superior abrasion resistance & durability

NYLON™-beschichtetes Band - überragend abriebresistent und hohe Dauerhaftigkeit
Ruban à revêtement NYLON™ garantissant une excellente résistance à l'abrasion et une longue durabilité
Cinta con recubrimiento NYLON™ para una resistencia superior a la abrasión y una mayor durabilidad

LACQUERED
LACKIERT
LAQUÉ
LACADA

NYLON™



Results of a stringent 15 litre sand blast test.

Ergebnis eines stringenten 15 Liter Sandblastest.
Résultats d'un essai rigoureux de sablage à 15 litres.
Resultados conseguidos mediante una rigurosa prueba con 15 litros de chorro de arena.

GEL-GRIP

- Fully featured tape measure - see previous feature page



Gel-grip tapes - 5m / 16ft

2004/22/EC Class 2

| Item Number | | i | |
|-------------|------|--------|---|
| T3445-16B | 19mm | blue | 6 |
| T3445-16G | 19mm | green | 6 |
| T3445-16O | 19mm | orange | 6 |
| T3445-16P | 19mm | purple | 6 |
| T3445-16R | 19mm | red | 6 |



Gel-grip tape - 7.5m / 25ft

2004/22/EC Class 2

| Item Number | | i | |
|-------------|------|--------|---|
| T3445-25 | 25mm | orange | 6 |

CONTENTS: 4 x blue, orange & green Gel-grip tapes, size 5m/16ft.



Gel-grip tapes display

2004/22/EC Class 2

| Item Number | | i | |
|---------------|-----------------|---|---|
| T3445-16-CBOX | stock & display | | 1 |

CONTENTS: 4 x blue, orange & green Gel-grip tapes, size 5m/16ft.

Gel-grip tapes display refill pack

2004/22/EC Class 2

| Item Number | | i | |
|---------------|------------|---|---|
| T3445-16-RFIL | stock only | | 1 |

TAPE MEASURES

- Tough ABS plastic body for damage protection
- Full lock & pause buttons for control
- Belt clip for convenience
- NYLONG™ coated blade for superior abrasion resistance & durability
- 16" & 400mm joist centre markings for fast marking out
- True zero hook for accurate external & internal measurements
- Integral recoil damper for hook damage protection



ST tape measures

2004/22/EC Class 2

| Item Number | | i | |
|-------------|-----------|-----------------|---|
| T3442 10 | 3m 10ft | metric/imperial | 6 |
| T3442 16 | 5m 16ft | metric/imperial | 6 |
| T3442 25 | 7.5m 25ft | metric/imperial | 6 |
| T3442M 3 | 3m | metric | 6 |
| T3442M 5 | 5m | metric | 6 |
| T3442M 8 | 8m | metric | 6 |

- Tough steel case for damage protection
- Fold out blade hook for secure anchoring
- Hand strap for convenient carrying
- Fold out winding handle for rapid rewind & safe storage
- Nylon coated steel tape - extremely strong & stretch resistant
- Double sided metric/imperial graduations

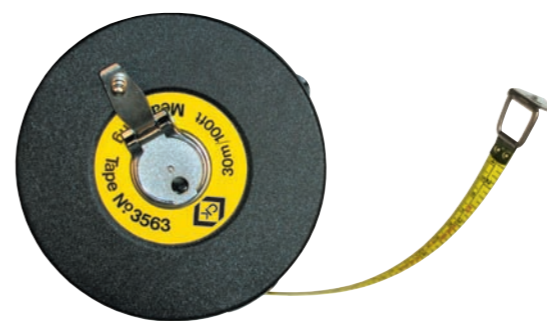

Measuring tape - Steel

2004/22/EC Class 3

| Item Number | | | |
|-------------|-----------|-----------|---|
| T3563 100 | 30m 100ft | 13mm 1/2" | 3 |

- Tough ABS plastic body for damage protection
- Fold out blade hook for secure anchoring
- Hand strap for convenient carrying
- Fold out winding handle for rapid rewind & safe storage
- Glassfibre reinforced tape - strong & stretch resistant
- Double sided metric/imperial graduations



Measuring tape - Fibreglass

2004/22/EC Class 3

| Item Number | | | |
|-------------|-----------|-----------|---|
| T3561 100 | 30m 100ft | 13mm 1/2" | 3 |

- Tough ABS plastic body for damage protection
- Integral ground spike & fold out blade hook for secure anchoring
- Soft grip handle for comfortable carrying
- Fold out winding handle for rapid rewind & safe storage
- Glassfibre reinforced tape - strong & stretch resistant
- Double sided metric/imperial graduations



Surveyor's tapes

2004/22/EC Class 3

| Item Number | | | |
|-------------|------------|-----------|---|
| T3565 100 | 30m 100ft | 13mm 1/2" | 3 |
| T3565 165 | 50m 165ft | 13mm 1/2" | 3 |
| T3565 330 | 100m 330ft | 13mm 1/2" | 3 |

RULES

- Stainless steel for corrosion protection
- Permanent indented markings for wear resistance
- Fine graduations for accurate measurements



Steel rules - Metric/imperial

| Item Number | Length | Thickness | Quantity |
|-------------|-----------|-----------|----------|
| T3530 06 | 150mm 6" | 18mm | 6 |
| T3530 12 | 300mm 12" | 25mm | 6 |

- High quality construction with brass hinges & end caps for durability
- Four fold design for compact storage
- Permanent indented markings for wear resistance



Wooden rule - Metric/imperial

| Item Number | Length | Quantity |
|-------------|--------|----------|
| T3510 | 1m 3ft | 6 |

- Anodised aluminium construction with a strong plastic handle - lightweight, easy clean
- Metric graduations
- Ideal for cutting, measuring and marking out



Straight edge/rule

| Item Number | Length | Quantity |
|-------------|------------|----------|
| T3531 100 | 1000mm 40" | 1 |

SPIRIT LEVELS

- Powder coated, box section aluminium - strong, light & durable
- Shockproof, unbreakable vials, guaranteed leakproof for three years
- Luminous horizontal vial for low light conditions
- Precision manufactured, accurate to +/- 0.5mm per metre
- Metric measurement graduations for convenience
- 16" (400mm) & 24" (600mm) feature 1 vertical & 1 horizontal vial
- 32" (800mm) and above feature 2 vertical & 1 horizontal vials



Aluminium box levels

| Item Number | Length | Vials | Quantity |
|-------------|------------|------------------|----------|
| T3494 16 | 400mm 16" | 2 vial with rule | 1 |
| T3494 24 | 600mm 24" | 2 vial with rule | 1 |
| T3494 32 | 800mm 32" | 3 vial with rule | 1 |
| T3494 40 | 1000mm 40" | 3 vial with rule | 1 |
| T3494 48 | 1200mm 48" | 3 vial | 1 |
| T3494 70 | 1800mm 70" | 3 vial | 1 |

- Tough ABS plastic body for damage protection
- V-groove base for pipework
- Magnetic base for steelwork
- Patented detachable mini level with magnetic base, ideal for setting patress boxes
- Also features string slots for use as line level
- 1 vertical & 1 horizontal vial



Pocket level

| Item Number | Length | Quantity |
|-------------|--------------|----------|
| T3482 | 210mm 8 1/4" | 5 |

CHALK, LINES & ACCESSORIES

- Die cast aluminium construction - strong & lightweight
- Fold away winding handle for convenient storage
- Self chalking line with end attachment hook for ease of use
- Supplied with 60g of blue chalk



Chalk line reel & chalk - Heavy duty

| Item Number | Length | Quantity |
|-------------|-----------|----------|
| T3520A | 30m 100ft | 6 |

- Tough plastic construction - strong & lightweight
- Fold away winding handle for convenient storage
- Self chalking line with end attachment hook for ease of use
- Supplied with 60g of blue chalk



Chalk line reel & chalk

| Item Number | Length | Quantity |
|-------------|-----------|----------|
| T3522 | 30m 100ft | 6 |

- Strong & absorbent cotton for effective retention of marking chalk



Chalk line - Cotton

| Item Number | Length | Quantity |
|-------------|----------|----------|
| T3517 | 18m 60ft | 12 |

- Braided nylon construction - extra strong & durable



Chalk line - Nylon

| Item Number | Length | Quantity |
|-------------|----------|----------|
| T3519 | 18m 60ft | 12 |

- High density chalk for clear marking results
- Plastic refill container with re-sealable dispenser cap



Chalk powders

| Item Number | Weight | Color | Quantity |
|-------------|----------|-------|----------|
| T3521B 100 | 100g 4oz | blue | 6 |
| T3521R 100 | 100g 4oz | red | 6 |

- Forged steel nickel plated for strength & corrosion resistance
- Suitable for use in wet & dry mortar



Line pins

| Item Number | Length | Quantity |
|-------------|--------------|----------|
| T3490 | 170mm 6 1/2" | set of 2 |

- Conical, fully polished bob complete with screwed brass cord fitting



Plumb bob

| Item Number | Weight | Quantity |
|-------------|-----------|----------|
| T3492 11 | 300g 11oz | 3 |

JOINER'S SQUARES & BEVELS

- Hardened & tempered blued steel blade for corrosion resistance
- Blade secured with three brass rivets & brass inside face for long term accuracy
- Hard rosewood stock



Joiner's squares - Rosewood

| Item Number | Length | Quantity |
|-------------|-----------|----------|
| T3540 09 | 225mm 9" | 3 |
| T3540 12 | 300mm 12" | 3 |

- Hardened & tempered blued steel blade for corrosion resistance
- Quick lock lever for convenient adjustment
- Hard rosewood stock



Sliding bevel - Rosewood

| Item Number | Length | Quantity |
|-------------|----------|----------|
| T3541 9 | 225mm 9" | 4 |

- Screw pin adjustment for accurate & consistent setting of mortice & tenon joints
- Heavy brass inlays on marking faces for protection
- Hard rosewood body



Marking & mortice gauge - Rosewood

| Item Number | Length | Quantity |
|-------------|-----------|----------|
| T3543 | 190mm 7½" | 1 |

- Hardened & tempered blued steel blade for corrosion resistance
- Blade secured with three brass rivets & brass inside face for long term accuracy
- Beech stock



Joiner's square - Beech

| Item Number | Length | Quantity |
|-------------|----------|----------|
| T3533 09 | 225mm 9" | 3 |

- Hardened & tempered blued steel blade for corrosion resistance
- Beechwood stock

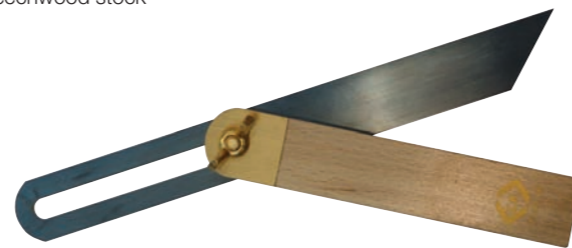

Sliding bevel - Beech

| Item Number | Length | Quantity |
|-------------|----------|----------|
| T3537 09 | 230mm 9" | 3 |

- Thumbscrew adjustment for accurate & consistent marking
- Brass inlays on marking faces for protection
- Beechwood body



Marking gauge - Beech

| Item Number | Length | Quantity |
|-------------|-----------|----------|
| T3542A | 240mm 9½" | 3 |

- Traditional rectangular leaded carpenters pencil



Carpenter's pencil

| Item Number | Quantity |
|-------------|----------|
| T1125 24 | 72 |

COMBINATION SQUARES

- Stainless steel rule for corrosion protection
- Permanent indented markings for wear resistance

- Heavy duty, 3 in 1 construction for a complete marking & measuring solution

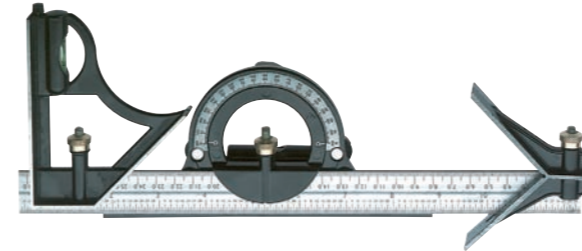

Combination square - 3 in 1

| Item Number | Length | Scale | Quantity |
|-------------|-----------|-----------------|----------|
| T3579 | 300mm 12" | metric/imperial | 1 |

- Heavy duty construction for strength & durability

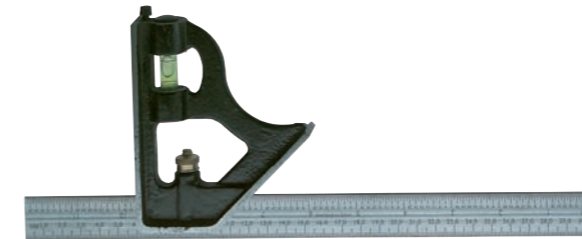

Combination square - Heavy duty

| Item Number | Length | Scale | Quantity |
|-------------|-----------|-----------------|----------|
| T3581 | 300mm 12" | metric/imperial | 3 |

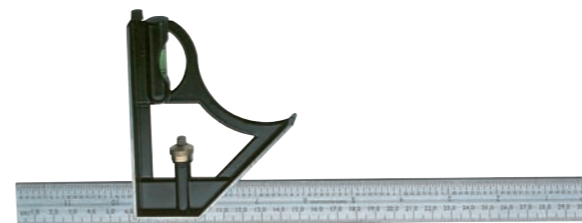

Combination square

| Item Number | Length | Scale | Quantity |
|-------------|-----------|-----------------|----------|
| T3582 | 300mm 12" | metric/imperial | 3 |

- Roller adjustment along metric & imperial graduated rule for convenience
- Nickel plated for corrosion protection

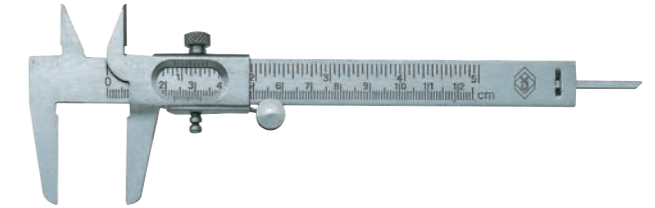

Vernier caliper

| Item Number | Length | Scale | Quantity |
|-------------|----------|-----------------|----------|
| T3451 | 125mm 5" | metric/imperial | 6 |

- Blades permanently etched with its size for long term use

CONTENTS (T3525 413): Imperial blades, sizes: 2, 3, 4, 5, 6, 8, 10, 12, 15, 20, 25, 30 & 35 thousandths of an inch.

CONTENTS (T3525M 413): Metric blades, sizes: 0.05, 0.10, 0.15, 0.20, 0.25, 0.30, 0.40, 0.50, 0.60, 0.70, 0.80, 0.90 & 1.00mm.



Feeler gauges

| Item Number | Length | Scale | Quantity |
|-------------|----------|----------|----------|
| T3525 413 | 100mm 4" | imperial | 3 |
| T3525M 413 | 100mm 4" | metric | 3 |

- Brass scale, black lacquered body, tinned hook & ring for corrosion resistance
- Calibrated in 1lb/0.5kg divisions

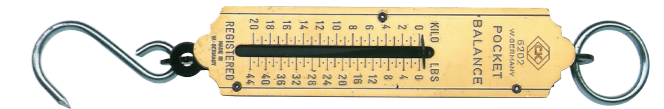

Pocket balances

| Item Number | Weight | Quantity |
|-------------|-------------|----------|
| T6202 025 | 12.5kg 25lb | 12 |
| T6202 032 | 15kg 32lb | 12 |
| T6202 044 | 20kg 44lb | 12 |
| T6202 050 | 23kg 50lb | 6 |
| T6202 066 | 30kg 66lb | 6 |
| T6202 088 | 40kg 88lb | 6 |
| T6202 112 | 50kg 112lb | 6 |

WOOD SAWS

HOLZSÄGEN
SCIES À BOIS
SIERRAS PARA MADERA

88-89

HACKSAWS

METALLSÄGEN
SCIES À MÉTAUX
ARCOS DE SIERRA

89-90

PLASTERBOARD SAW

GIPSKARTONSÄGE
SCIE À GUICHET (POUR LE PLÂTRE)
SIERRA PARA YESO

90

TRIMMING KNIVES

TEPPICHMESSER
CUTTERS
CUCHILLOS DE RECORTE

91-93

WOOD CHISELS

STECHBEITEL
CISEAUX À BOIS
CINCELES PARA MADERA

93

SAWING & CUTTING

SÄGEN & SCHNEIDEN
SCIAGE ET DÉCOUPE
ASERRADO Y CORTADO



SABRETOOTH

HIGH PERFORMANCE WOOD SAWS

HOCHLEISTUNGS HOLZSÄGEN

SCIES A BOIS DE HAUTE PERFORMANCE

MADERA DE ALTO RENDIMIENTO SIERRAS



1 Triple edge, precision ground teeth specially designed to offer an easy start & outstanding cutting performance on both the push & pull stroke

Dreifachschneidende präzisionsgeschliffene Zähne, speziell entwickelt für leichtes Ansägen und überragende Sägeleistung sowohl beim Stoß- als auch beim Zughub

Dents à triple biseau à rectification de précision spécialement conçues pour offrir un départ aisé et de remarquables performances de coupe, à la traction comme à la poussée

Dientes de sierra afilados de alta precisión con triple borde especialmente diseñados para ofrecer un rendimiento de corte inicial fácil y excelente en el efecto de empuje y tracción

2 Induction hardened teeth for longer lasting sharpness

Induktionsgehärtete Zähne für lang anhaltende Schärfe

Dents trempées par induction pour un affûtage qui dure plus longtemps

Dientes de sierra templados por inducción para proporcionar unafilado de mayor duración

3 Rigid 1mm special alloy steel blade prevents whip & snagging

Robustes 1-mm-Sägeblatt aus spezieller Stahllegierung, die Durchbiegen und Blockieren verhindert

La lame rigide en acier allié spécial de 1 mm prévient le fouettement et les coincements

La hoja rígida de acero de aleación especial de 1 mm evita la torsión y el atascamiento de la sierra

4 Ergonomic two component cushion grip handle with finger index for superior comfort & control

Ergonomisch gepolsterter Handgriff aus zwei Komponenten mit Fingerreihe für überragenden Komfort und bessere Handhabung

Poignée rembourrée bicomposant ergonomique avec position d'appui pour l'index, pour un excellent confort et une meilleure maîtrise de l'outil

Mango ergonómico con mango de dos componentes de agarre acolchado para el dedo índice para máxima comodidad y control

OUT PERFORMS THE BEST*

DEN BESTEN ÜBERLEGEN*

LES MEILLEURS RÉSULTATS*

DE MAYOR RENDIMIENTO*

1 BLOCK 100 BLOCKS
1 BLOCK 100 BLÖCKE
1 BLOC 100 BLOCS
1 BLOQUE 100 BLOQUES

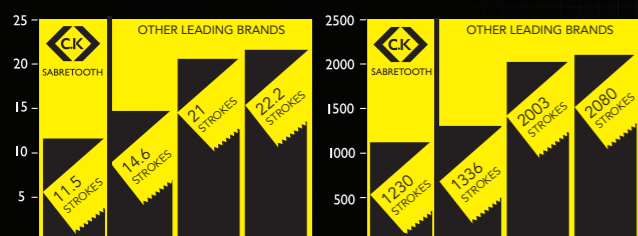

SABRETOOTH



*First fix saw tested against UK's market leading saws in independent CATRA tests.

*Testsieger gegen marktführende Sägen in Großbritannien im unabhängigen CATRA-Test

*Scie premier passage testée par rapport aux scies dominant le marché britannique dans le cadre d'essais réalisés par l'organisme indépendant CATRA.

*La primera opción en sierras, comparadas con las sierras líderes en el mercado del Reino Unido mediante la realización de pruebas independientes CATRA.



WOOD SAWS



Sabretooth wood saws

| Item Number | Length | Teeth | Quantity |
|-------------|--------|--------------------------|----------|
| 481001 | 22" | 7tpi / 8ppi first fix | 10 |
| 481002 | 22" | 11tpi / 12ppi second fix | 10 |

CONTENTS: 10 x Sabretooth wood saws.



Sabretooth wood saws display

| Item Number | Length | Teeth | Quantity |
|-------------|--------|--------------------------|----------|
| 581001 | 22" | 7tpi / 8ppi first fix | 1 |
| 581002 | 22" | 11tpi / 12ppi second fix | 1 |

- Nickel plated flat steel frame for strength & corrosion protection
- 115mm throat for deep cuts
- 360° adjustable blade for intricate cutting

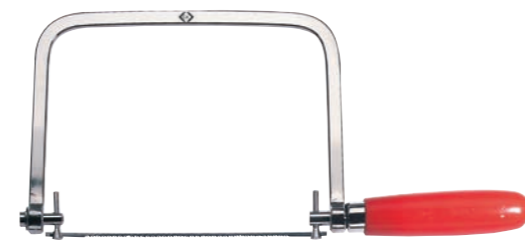

Coping saw

| Item Number | Length | Quantity |
|-------------|--------------|----------|
| T0828 | 162mm 6 1/2" | 3 |

Coping saw blades - Pack of 10

| Item Number | Length | Quantity |
|-------------|--------------|----------|
| T0829 | 162mm 6 1/2" | 10 |

HACKSAWS

- Heavy duty premium quality hacksaw with rubber grips for comfort & control
- Quick release blade change mechanism for convenience
- High leverage blade tensioning system for straighter cuts
- Spare blade storage in back frame for convenience
- 45 & 90° blade positions



Hacksaw - Quick change

| Item Number | Length | Teeth | Quantity |
|-------------|-----------|-------|----------|
| T0814 | 300mm 12" | 24 | 3 |

- Heavy duty, box section steel frame with aluminium handle for strength & durability
- High leverage blade tensioning system for straighter cuts
- Spare blade storage in back frame for convenience
- 45 & 90° blade positions



Hacksaw - Heavy duty

| Item Number | Length | Teeth | Quantity |
|-------------|-----------|-------|----------|
| T0905 | 300mm 12" | 24 | 3 |

- Box section steel frame with aluminium handle - tough & lightweight
- Spare blade storage in back frame for convenience
- 90° blade positions

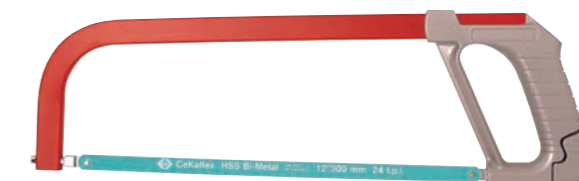

Hacksaw

| Item Number | Length | Teeth | Quantity |
|-------------|-----------|-------|----------|
| T0903 12 | 300mm 12" | 24 | 3 |

- Shatterproof HSS Bi-metal construction



Hacksaw blades

| Item Number | Length | tpi | i | Box |
|-------------|-----------|-----|-----|-----|
| T0931R 12 | 300mm 12" | 24 | x 3 | 12 |
| T0932R 12 | 300mm 12" | 18 | x 1 | 50 |
| T0933R 12 | 300mm 12" | 24 | x 1 | 50 |
| T0934R 12 | 300mm 12" | 32 | x 1 | 50 |

CONTENTS: 18 x hacksaw blades, sizes: 18, 24 & 32 tpi.



Hacksaw blade display

| Item Number | i | Box |
|-------------|-----------------|-----|
| T0930RBOM | Stock and stand | 1 |

- Cast aluminium frame for strength
- Broad handle for comfort
- Adjustable blade for angled cutting
- Special screw tensioner for fast & simple blade fitting



Mini hacksaw

| Item Number | Length | Box |
|-------------|----------|-----|
| T0836A | 150mm 6" | 6 |

- Cast aluminium frame for strength
- Broad handle for comfort
- Adjustable blade for angled cutting
- Special screw tensioner for fast & simple blade fitting
- Supplied with lightweight 3 angle mitre box



Mini hacksaw & mitre box

| Item Number | Length | Box |
|-------------|-----------|-----|
| T0837 | 300mm 12" | 5 |

- Non protruding blade fixing for safety



Junior hacksaw

| Item Number | Length | Box |
|-------------|----------|-----|
| T0834 | 150mm 6" | 6 |



Junior hacksaw blades

| Item Number | Length | i | Box |
|-------------|----------|------|-----|
| T0835 | 150mm 6" | x 10 | 10 |

PLASTERBOARD SAWS

- Induction hardened coarse ground cutting teeth & pointed blade for fast cutting of holes in plasterboard for sockets & conduits (Also known as a dry wall saw)



Plasterboard saw

| Item Number | Length | Box |
|-------------|----------|-----|
| T0831 | 150mm 6" | 10 |

TRIMMING KNIVES TEPPICHMESSER CUTTERS CUCHILLOS DE RECORTE



1 Robust, die cast aluminium housing - strong & lightweight

Robustes Aluminiumgussgehäuse - stabil und leicht
Boîtier robuste en aluminium moulé sous pression - solide et léger
Con carcasa de aluminio fundido, robusto, resistente y de peso ligero

2 Safety interlocking design to prevent the blade slipping through the body joint

Sicherheitsverriegelung, um das Zurückgleiten der Klinge in das Gehäuse zu vermeiden
Emboîtement de sûreté pour prévenir tout glissement de la lame au niveau du joint du corps de l'outil
Junta entrelazada de seguridad para evitar que la hoja se escurra por la junta del cuerpo

3 Ergonomically designed, soft grip handle for increased comfort & control

Ergonomisch gestalteter weicher Handgriff für erhöhten Komfort und bessere Handhabung
Poignée de conception ergonomique à revêtement souple pour un confort accru et une meilleure maîtrise de l'outil
Ergonómicos, con mango de agarre suave para una mayor comodidad y control

4 Magnetic blade retainer & captive body screw for quick & easy blade changes

Magnetischer Klingenhalter und nicht verlierbarer Schraube am Messerkörper für schnellen und einfachen Klingenswechsel
Porte-lame magnétique et vis de corps captive pour des changements de lame rapides et faciles
Retén de la cuchilla magnético y tornillo de sujeción del cuerpo para un cambio de las cuchillas fácil y rápido

5 Retractable blade for safe storage

Einziehbare Klinge für sichere Aufbewahrung
Lame rétractable pour un rangement sûr
Cuchilla retráctil para un almacenamiento seguro

6 String/wire cutting notch for convenience

Schnur/Drahtschneidenute zur vorteilhaften Anwendung
Encoche coupe-ficelles et coupe-fils pour le confort d'utilisation
Incluye una muesca para cortar cuerda y alambre

7 Internal 5 blade storage compartment

Internes Aufbewahrungsfach für 5 Klinsen
Compartment de rangement interne pour 5 lames
Compartimento de almacenamiento interno para 5 cuchillas



TRIMMING KNIVES

- Fully featured trimming knife - see previous page for details



Soft grip trimming knife - Retractable

| Item Number | |
|-------------|---|
| T0957-1 | 6 |

- Ergonomically designed, soft grip handle for increased comfort & control
- Robust, die cast aluminium housing both strong and lightweight
- Safety interlocking joint to prevent the blade slipping through the body joint
- Magnetic blade retainer & captive body screw for quick & easy blade changes
- Internal 5 blade storage compartment



Soft grip trimming knife - Non retractable

| Item Number | |
|-------------|---|
| T0957-2 | 6 |

- Auto retracting blade for safety in use & storage
- Robust, die cast aluminium housing both strong and lightweight
- Safety interlocking joint to prevent the blade slipping through the body joint



Trimming knife - Auto retracting

| Item Number | |
|-------------|---|
| T0969 | 6 |

- Robust, die cast aluminium housing both strong and lightweight
- Safety interlocking joint to prevent the blade slipping through the body joint
- Magnetic blade retainer & captive body screw for quick & easy blade changes
- Retractable blade for safe storage
- String/wire cutting notch for convenience
- Internal 5 blade storage compartment



Trimming knife - Retractable

| Item Number | |
|-------------|---|
| T0956-1 | 6 |

- Robust, die cast aluminium housing both strong and lightweight
- Safety interlocking joint to prevent the blade slipping through the body joint
- Magnetic blade retainer & captive body screw for quick & easy blade changes
- Internal 5 blade storage compartment



Trimming knife - Non retractable

| Item Number | |
|-------------|---|
| T0956-2 | 6 |

- Heavy duty blades supplied in a spring loaded blade dispenser for safety & convenient storage



Spare blades - Standard

| Item Number | | |
|-------------|-------|----|
| T0959-10 | x 10 | 12 |
| T0959-50 | x 50 | 12 |
| T0959-100 | x 100 | 12 |

- Heavy duty plastic body with soft grip handle for comfort & control
- Push button blade positioning with locking system for control & safety
- Integrated blade snapper for safe blade segment removal
- Supplied with 4 blades stored in the handle for convenience



Trimming knife - Snap off blade

| Item Number | |
|-------------|----|
| T0958 | 12 |

- Heavy duty blades supplied in a spring loaded blade dispenser for safety & convenient storage



Spare blades - Snap off

| Item Number | | |
|-------------|------|----|
| T0971-10 | x 10 | 12 |

WOOD CHISELS

- Finest chrome vanadium steel, full length hardened & tempered for long life performance
- Shatterproof acetate handle for safety
- Replaceable blade cover for protection & safety



Wood chisels

| Item Number | | |
|-------------|-------------|---|
| T1178 025 | 6mm 1/4" | 3 |
| T1178 037 | 10mm 3/8" | 3 |
| T1178 050 | 13mm 1/2" | 3 |
| T1178 062 | 16mm 5/8" | 3 |
| T1178 075 | 19mm 3/4" | 3 |
| T1178 087 | 22mm 7/8" | 3 |
| T1178 100 | 25mm 1" | 3 |
| T1178 125 | 32mm 1 1/4" | 3 |
| T1178 150 | 38mm 1 1/2" | 3 |

- Supplied with silicone carbide sharpening stone & protective storage case

CONTENTS: 1 x wood chisel, sizes: 6, 13, 19, & 25mm. Sharpening stone.



Wood chisels & sharpening stone set

| Item Number | | |
|-------------|-------------|---|
| T1180 | 5 piece set | 3 |

- Double sided medium/fine silicon carbide sharpening stone, ideal for sharpening chisels, scissors, shears, etc.



Sharpening stone

| Item Number | | |
|-------------|------------|---|
| T1126 | 200 x 50mm | 1 |

CONTENTS: 3 x wood chisels, sizes: 6, 10, 13, 16, 19, 22, 25, 32 & 38mm. Sharpening stone.



Wood chisel display

| Item Number | | |
|-------------|-----------------|---|
| T1179LS | Stock and stand | 1 |

SOCKETS, SPANNERS & WRENCHES

STECKSCHLÜSSEL & SCHRAUBENSCHLÜSSEL
DOUILLES ET CLÉS
CASQUILLOS, LLAVES DE TUERCAS Y LLAVES INGLESAS

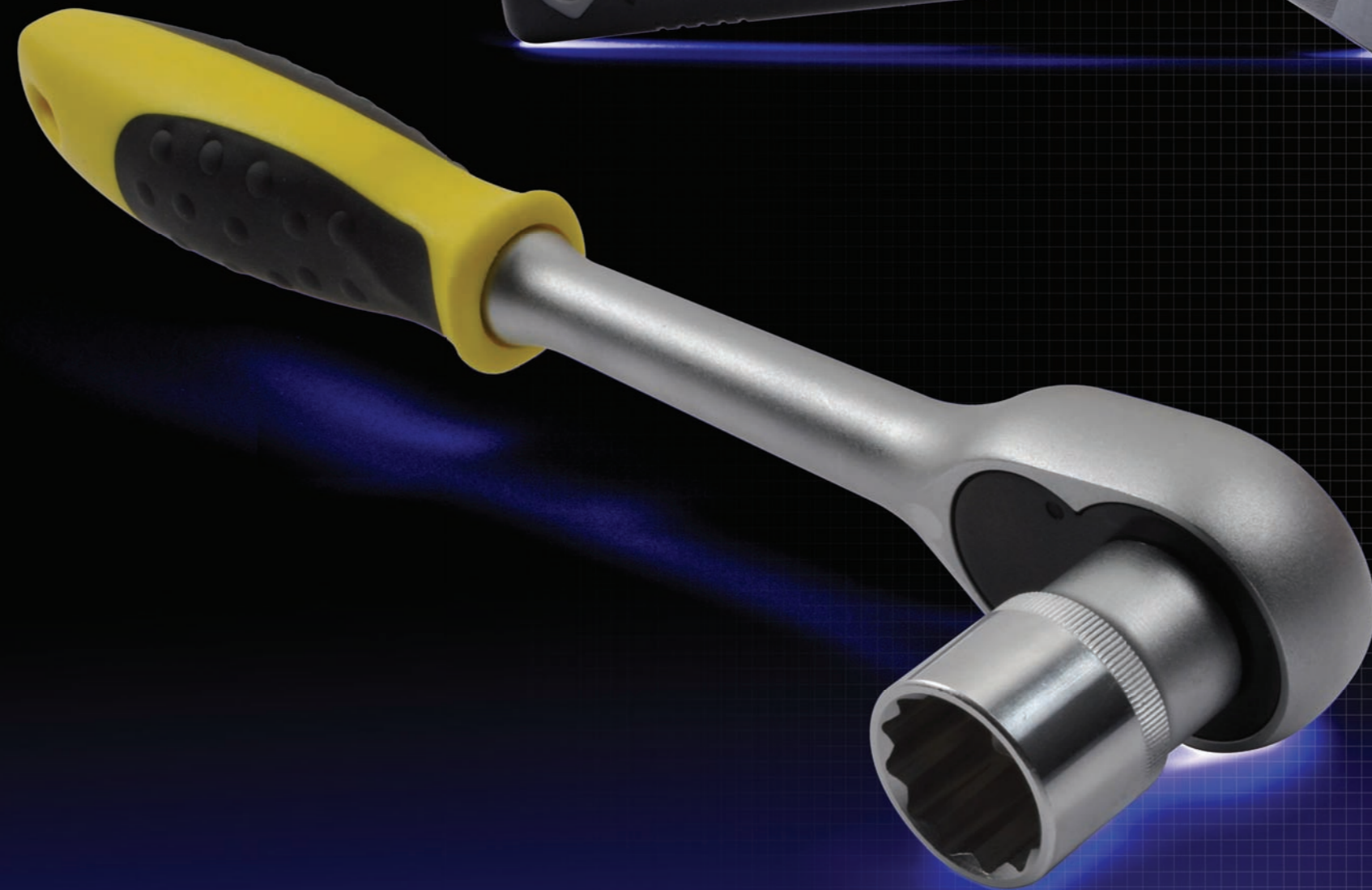

SURE DRIVE SOCKETS & ACCESSORIES

STECKSCHLÜSSEL UND ZUBEHÖR
DOUILLES ET ACCESSOIRES
VASOS Y ACCESORIOS

96-98

SURE DRIVE SOCKET SETS

SURE DRIVE STECKSCHLÜSSELSÄTZE
JEUX DE DOUILLES SURE DRIVE
SURE DRIVE SETS DE VASOS

99

SPANNERS

SCHRAUBENSCHLÜSSEL
CLÉS
LLAVES FIJAS

100-101

WRENCHES

VERSTELLBARE SCHRAUBENSCHLÜSSEL
CLÉS
LLAVES

101-102

HEXAGON KEYS

INNENSECHSKANTSCHLÜSSEL
CLÉS MÂLES À SIX PANS
LLAVES HEXAGONALES

102-103



SURE-DRIVE ADVANCED NUT DRIVING SYSTEM

SCHRAUBEN- UND MUTTERSCHONENDES ANTRIEBSSYSTEM
SYSTEME DE VISSAGE D'ECROU AVANCE "ANTI-ARRONDISSEMENT"
SISTEMA AVANZADO DE APRIETE Y PROTECCIÓN DE TUERCA



RATCHET HANDLE

KNARREN
CLÉ À CLIQUET
LLAVES CARRACA

1 Heavy duty chrome vanadium construction for superior strength & durability

Hoch belastbare Chrom-Vanadiumstahl-Ausführung für überragende Festigkeit und Dauerhaftigkeit
Réalisation robuste en acier au chrome-vanadium, garantissant une résistance et une durabilité excellentes
Construcción en cromo-vanadio de gran resistencia para una superior durabilidad

2 Reversible, 45 tooth ratchet mechanism for a finer working arc (8° arc)

Umkehrbarer 45-Zähne-Ratschenmechanismus für einen feineren Betätigungswinkel (8°)
Mécanisme de cliquet réversible à 45 dents pour un arc de travail plus fin (8°)
Mecanismo de trinquete reversible de 45 dientes para un arco de trabajo más fino (arco de 8°)

3 Ball bearing locking system with push button release mechanism for quick inter-change of sockets

Kugelgelagertes Arretierungssystem mit Freigabe durch Drucktaste für schnelles Auswechseln der Steckschlüssel
Système de verrouillage à roulement à billes avec mécanisme de déblocage par bouton-poussoir pour un changement de douille rapide
Sistema de bloqueo de cojinete de bolas con un mecanismo de liberación mediante pulsador para el intercambio rápido de los vasos

4 Dual component, non slip grip for added comfort & control

Nicht rutschender Zweikomponentengriff für zusätzlichen Komfort und bessere Handhabung
Poignée antidérapante bicomposant pour plus de confort et une meilleure maîtrise de l'outil
Mango de dos componentes, agarre antideslizante para mayor comodidad y control

SOCKETS

STECKSCHLÜSSEL
DOUILLES
VASOS

5 Forged Chrome Vanadium steel for superior strength & durability

Geschmiedeter Chrom-Vanadiumstahl für überragende Festigkeit und Dauerhaftigkeit
Acier au chrome-vanadium forgé, garantissant une résistance et une durabilité excellentes
Acero de cromo-vanadio para una resistencia y una durabilidad superiores

6 Non slip, satin chrome plated for resistance to rust & peeling

Nicht rutschend, matt verchromt für den Schutz gegen Rost und Abblättern
Finition chromée satinée antidérapante pour la protection antirouille et la résistance à l'écaillage.
Plateado al cromo satinado antideslizante, para resistencia al óxido y evitar el descascarillarse

7 C.K. 'Sure-drive' system applies torque to the flat of the nut rather than the corners to avoid rounding off

C.K. 'Sure-drive'-System, welches das Drehmoment eher auf die Fläche der Mutter als auf die Ecken überträgt, um Abrunden zu vermeiden
Le système 'Sure-drive' de C.K applique le couple sur le pan de l'écrou plutôt que sur les arêtes, évitant ainsi de les arrondir (usure)
El sistema C.K. 'Sure-drive' aplica par a las caras de la tuerca y no a los ángulos para evitar el redondeado de éstos

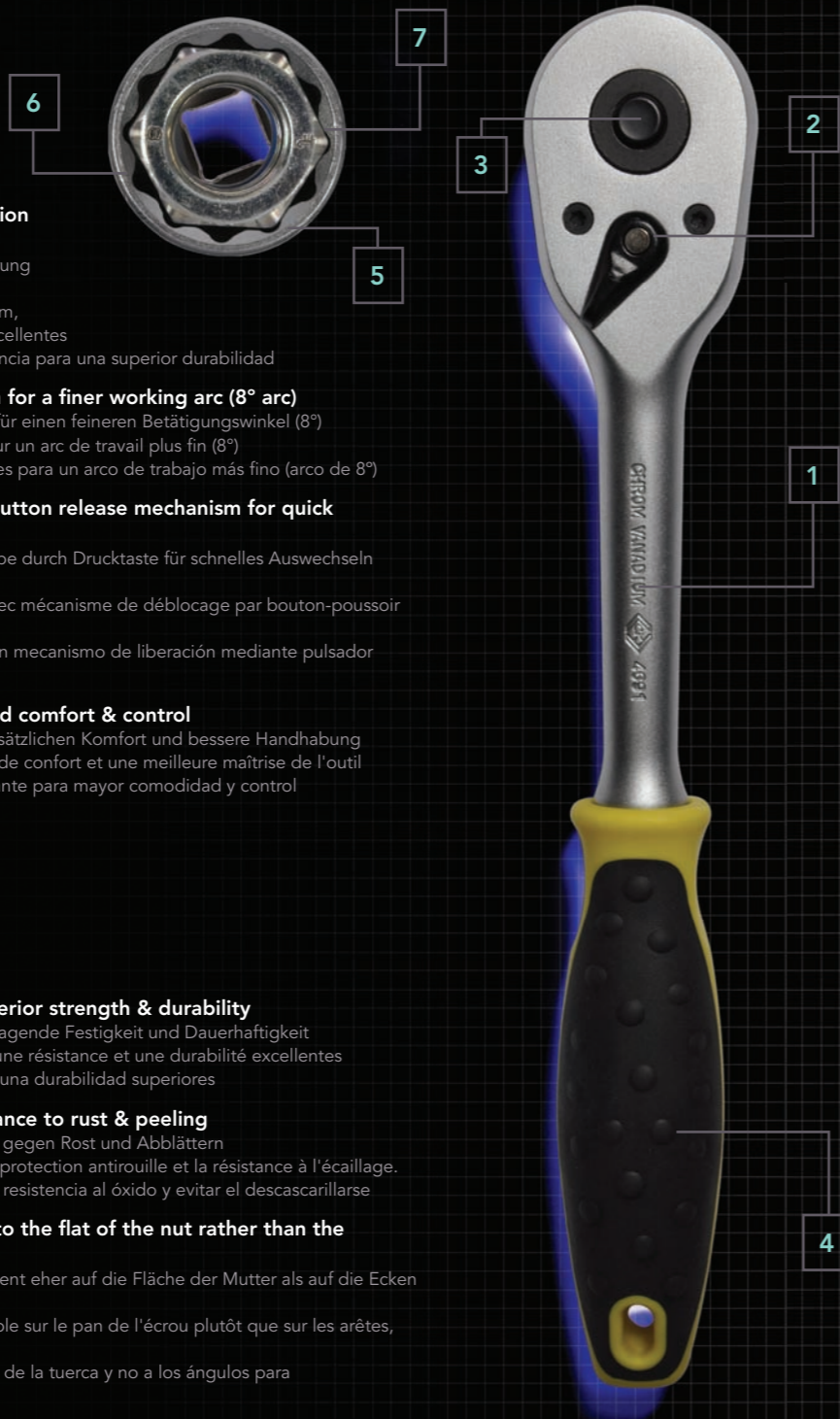

SURE-DRIVE SOCKETS & ACCESSORIES



Sockets -
1/2" drive metric

| Item Number | ↔ | 📦 |
|-------------|------|---|
| T4690M 10 | 10mm | 5 |
| T4690M 11 | 11mm | 5 |
| T4690M 12 | 12mm | 5 |
| T4690M 13 | 13mm | 5 |
| T4690M 14 | 14mm | 5 |
| T4690M 15 | 15mm | 5 |
| T4690M 16 | 16mm | 5 |
| T4690M 17 | 17mm | 5 |
| T4690M 18 | 18mm | 5 |
| T4690M 19 | 19mm | 5 |
| T4690M 20 | 20mm | 5 |
| T4690M 21 | 21mm | 5 |
| T4690M 22 | 22mm | 5 |
| T4690M 23 | 23mm | 5 |
| T4690M 24 | 24mm | 5 |
| T4690M 27 | 27mm | 5 |
| T4690M 30 | 30mm | 5 |
| T4690M 32 | 32mm | 5 |

- Heavy duty chrome vanadium construction for superior strength and durability
- Micrometer sleeve for accurate torque setting
- Individually calibrated and supplied with a certificate of calibration
- Supplied in a protective storage case complete with 120mm extension drive & 3/8" square drive adapter



Torque wrench -
1/2" drive

DIN 3122

| Item Number | ↔ | i | 📦 |
|-------------|-----------|------------------------|----|
| T4463 | 600mm 18" | 42-210Nm / 30-154lb-ft | 12 |

CONTENTS: 3 x sockets, size: 10, 11, 12, 13, 14, 15, 16, 17, 18, 19, 20 & 21. 2 x sockets, size: 22, 23, 24, 27, 30 & 32mm.



Sockets display stand

| Item Number | i | 📦 |
|-------------|-----------------|---|
| T4644RBOM | stock and stand | 1 |

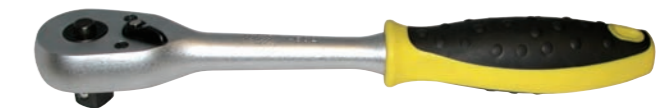

Ratchet handle -
1/2" drive 45 teeth

| Item Number | 📦 |
|-------------|---|
| T4691 | 5 |

- Heavy duty chrome vanadium construction for superior strength and durability
- Dual component, non slip grip for added comfort & control



Flexible handle -
1/2" drive

| Item Number | ↔ | 📦 |
|-------------|-----------|---|
| T4692 | 430mm 17" | 5 |

- Reversible, 24 tooth ratchet mechanism for high torque applications
- Heavy duty chrome vanadium construction for superior strength & durability
- Ball bearing locking system with push button release mechanism for quick inter-change of sockets



Ratchet handle -
1/2" drive 24 teeth

| | |
|-------------|---|
| Item Number | |
| T4603 | 3 |

Ratchet handle -
1/2" drive 24 teeth - repair kit

| | |
|-------------|---|
| Item Number | |
| T4603 1 | 1 |

- Heavy duty chrome vanadium construction for superior strength & durability



Sliding T-handle -
1/2" drive

| | |
|-------------|-------------|
| Item Number | |
| T4695 | 250mm 10" 5 |

- Heavy duty chrome vanadium construction for superior strength & durability



Long extension -
1/2" drive

| | |
|-------------|-------------|
| Item Number | |
| T4693 | 250mm 10" 5 |

- Heavy duty chrome vanadium construction for superior strength & durability



Short extension -
1/2" drive

| | |
|-------------|------------|
| Item Number | |
| T4694 | 125mm 5" 5 |

- Heavy duty chrome vanadium construction for superior strength & durability



Universal joint -
1/2" drive

| | |
|-------------|---|
| Item Number | |
| T4696 | 5 |

CONTENTS: 3 x ratchet handle. 3 x sliding t-handle. 3 x flexible handle. 3 x long extension. 3 x short extension. 3 x universal joint.

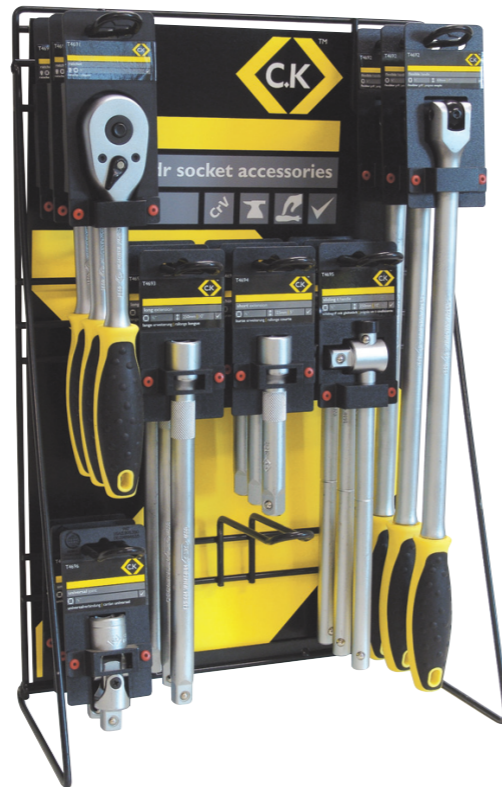

Socket accessory bar -
1/2" drive

| | |
|-------------|-------------------|
| Item Number | |
| T4645RBOM | stock and stand 1 |

SURE-DRIVE SOCKET SETS

CONTENTS: 45 tooth ratchet handle. 1 x socket, sizes: 10, 11, 12, 13, 14, 15, 16, 17, 18, 19, 22, 24, 27, 30 & 32mm. 1 x long reach socket, sizes: 16 & 21mm. Long extension. Short extension. Universal joint. 3/8" drive adaptor/t-handle adaptor.



Socket set - 22 Piece
1/2" drive metric

| | |
|-------------|---|
| Item Number | |
| T4657 | 1 |

CONTENTS: 45 tooth ratchet handle. 1 x socket, sizes: 6, 7, 8, 9, 10, 11, 12, 13, 14, 15, 16, 17, 18, 19, 20, 21, 22 & 24mm. Long extension. Short extension. Universal joint. 1/2" drive adaptor/t-handle adaptor.

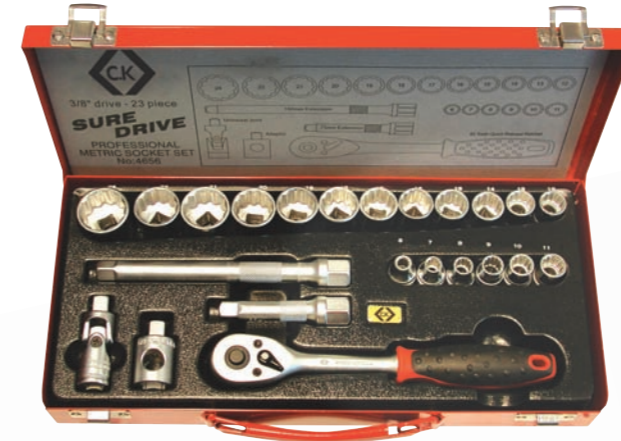

Socket set - 23 Piece
3/8" drive metric

| | |
|-------------|---|
| Item Number | |
| T4656 | 2 |

CONTENTS: 45 tooth ratchet handle. 1 x socket, sizes: 4, 4.5, 5, 5.5, 6, 7, 8, 9, 10, 11, 12, 13 & 14mm. 1 x hexagon socket bit, sizes: 3, 4, 5 & 6mm. 1 x tamperproof TX socket bit, sizes: 8, 10, 15, 20, 25, 27, 30 & 40. 1 x socket bit, slotted, sizes: 4, 5.5 & 7mm; PZ, sizes: 1, 2 & 3; PH, sizes: 1, 2 & 3. Short extension. 1/4" drive handle. Universal joint. Hex to 1/4" drive adaptor.



Socket set - 39 Piece
1/4" drive metric

| | |
|-------------|---|
| Item Number | |
| T4655 | 3 |



SPANNERS

- Drop forged chrome vanadium steel, hardened & tempered for strength & durability
- Heavy duty chrome plated for corrosion resistance
- 12° offset bi-hex ring for access



Combination spanners - Metric

DIN 3113

| Item Number | Length | Width | Material | Quantity |
|-------------|--------|-------|-----------|----------|
| T4343M 06 | 100mm | 6mm | loose | 10 |
| T4343M 06H | | | on hanger | 6 |
| T4343M 07 | 110mm | 7mm | loose | 10 |
| T4343M 07H | | | on hanger | 6 |
| T4343M 08 | 120mm | 8mm | loose | 10 |
| T4343M 08H | | | on hanger | 6 |
| T4343M 09 | 130mm | 9mm | loose | 10 |
| T4343M 09H | | | on hanger | 6 |
| T4343M 10 | 140mm | 10mm | loose | 10 |
| T4343M 10H | | | on hanger | 3 |
| T4343M 11 | 150mm | 11mm | loose | 10 |
| T4343M 11H | | | on hanger | 3 |
| T4343M 12 | 160mm | 12mm | loose | 10 |
| T4343M 12H | | | on hanger | 3 |
| T4343M 13 | 170mm | 13mm | loose | 10 |
| T4343M 13H | | | on hanger | 3 |
| T4343M 14 | 180mm | 14mm | loose | 10 |
| T4343M 14H | | | on hanger | 6 |
| T4343M 15 | 190mm | 15mm | loose | 10 |
| T4343M 15H | | | on hanger | 6 |
| T4343M 16 | 200mm | 16mm | loose | 10 |
| T4343M 16H | | | on hanger | 6 |
| T4343M 17 | 210mm | 17mm | loose | 10 |
| T4343M 17H | | | on hanger | 3 |
| T4343M 18 | 220mm | 18mm | loose | 10 |
| T4343M 18H | | | on hanger | 1 |
| T4343M 19 | 230mm | 19mm | loose | 10 |
| T4343M 19H | | | on hanger | 1 |
| T4343M 20 | 240mm | 20mm | loose | 5 |
| T4343M 20H | | | on hanger | 1 |
| T4343M 21 | 250mm | 21mm | loose | 5 |
| T4343M 21H | | | on hanger | 1 |
| T4343M 22 | 260mm | 22mm | loose | 5 |
| T4343M 22H | | | on hanger | 1 |
| T4343M 24 | 280mm | 24mm | loose | 5 |
| T4343M 24H | | | on hanger | 1 |

Continued in the next column

| | | | | |
|------------|-------|------|-----------|---|
| T4343M 27 | 310mm | 27mm | loose | 5 |
| T4343M 27H | | | on hanger | 1 |
| T4343M 30 | 340mm | 30mm | loose | 5 |
| T4343M 30H | | | on hanger | 1 |
| T4343M 32 | 360mm | 32mm | loose | 5 |
| T4343M 32H | | | on hanger | 1 |

- Supplied in a wall mounting rack for convenient storage

CONTENTS: 1 x combination spanner, sizes: 8, 9, 10, 11, 12, 13, 14, 15, 17, 19, 21 & 22mm.



Combination spanners set - 12 Piece metric

DIN 3113

| Item Number | Quantity |
|-------------|----------|
| T4343M/12ST | 1 |

- Supplied in a wall mounting rack for convenient storage

CONTENTS: 1 x combination spanner, sizes: 8, 9, 10, 11, 12, 13, 14, 15, 17, & 19mm.



Combination spanners set - 10 Piece metric

DIN 3113

| Item Number | Quantity |
|-------------|----------|
| T4343M/10ST | 3 |

CONTENTS: 2 x combination spanners, sizes: 6, 7, 8, 9, 10, 11, 12, 13, 14, 15, 16, 17, 18, 19, 20, 21, 22 & 24mm.
1 x combination spanners, sizes: 27, 30 & 32mm.



Combination spanner display

| Item Number | Description | Quantity |
|-------------|-----------------|----------|
| T4343MRBOM | stock and stand | 1 |

- Drop forged chrome vanadium steel, hardened & tempered for strength & durability
- Colour coded for quick selection of the correct size
- Innovative ratchet action style jaw for use in tight places
- 12° offset bi-hex ring for access
- Supplied in a wall mounting rack for convenient storage

CONTENTS: 1 x combination spanner, sizes: 10, 12, 13, 14, 15 & 17mm



Speed spanners set - 6 Piece metric

| Item Number | Quantity |
|-------------|----------|
| T4345/6ST | 5 |

WRENCHES

- Sure-drive jaws which apply torque to the flat of the nut rather than the corners to avoid rounding off
- Extra capacity jaws - up to 18% wider than standard patterns



Adjustable wrench - Sure drive

| Item Number | Length | Width | Quantity |
|-------------|-----------|-------|----------|
| T4365 150 | 150mm 6" | 24mm | 3 |
| T4365 200 | 200mm 8" | 29mm | 3 |
| T4365 250 | 250mm 10" | 33mm | 3 |
| T4365 300 | 300mm 12" | 38mm | 3 |

- Extra capacity jaws - up to 26% wider than standard patterns



Adjustable wrenches - Wide jaw

| Item Number | Length | Width | Quantity |
|-------------|-----------|-------|----------|
| T4366 150 | 150mm 6" | 24mm | 6 |
| T4366 200 | 200mm 8" | 29mm | 6 |
| T4366 250 | 250mm 10" | 33mm | 6 |
| T4366 300 | 300mm 12" | 38mm | 6 |
| T4366 375 | 375mm 15" | 51mm | 5 |
| T4366 450 | 450mm 18" | 60mm | 5 |

- Chrome plated for corrosion resistance



Adjustable wrenches - Standard

| Item Number | Length | Width | Quantity |
|-------------|-----------|-------|----------|
| T4368 150 | 150mm 6" | 19mm | 6 |
| T4368 200 | 200mm 8" | 24mm | 6 |
| T4368 250 | 250mm 10" | 29mm | 6 |
| T4368 300 | 300mm 12" | 34mm | 6 |

- Concave jaws ideal for gripping round profile
- Integral wire cutting blades for convenience



Self grip wrenches - Concave jaws

| Item Number | Length | Width | Depth |
|-------------|-----------|-------|-------|
| T3630 10 | 250mm 10" | 50mm | 5 |

- Combination straight & curved jaws ideal for gripping round, flat & square profile



Self grip wrenches - Straight/curved jaws

| Item Number | Length | Width | Depth |
|-------------|-----------|-------|-------|
| T3638 07 | 180mm 7" | 25mm | 6 |
| T3638 10 | 250mm 10" | 35mm | 6 |

- Flat jaws ideal for gripping flat profile



Self grip wrenches - Straight jaws

| Item Number | Length | Width | Depth |
|-------------|-----------|-------|-------|
| T3641 | 250mm 10" | 40mm | 5 |

- High quality drop forged steel construction with hardened & tempered jaws for strength & durability
- Patented head design for high torque performance



Stillson wrenches

| Item Number | Length | Width | Depth |
|-------------|-----------|-------|-------|
| T3735 300 | 300mm 12" | 38mm | 8 |
| T3735 350 | 350mm 14" | 55mm | 8 |
| T3735 400 | 450mm 18" | 55mm | 8 |
| T3735 600 | 600mm 24" | 70mm | 8 |

HEXAGON KEYS

- Chrome vanadium steel, hardened & tempered for strength & durability



Hexagon keys - Metric

ISO 2936

| Item Number | Width | Length | Tip | Count |
|-------------|--------|--------|------|-------|
| T4411 007 | 0.7mm | 32mm | 6mm | 12 |
| T4411 009 | 0.9mm | 32mm | 10mm | 12 |
| T4411 01 | 1.0mm | 32mm | 10mm | 12 |
| T4411 012 | 1.2mm | 38mm | 10mm | 12 |
| T4411 0127 | 1.27mm | 40mm | 12mm | 12 |
| T4411 015 | 1.5mm | 45mm | 14mm | 12 |
| T4411 02 | 2.0mm | 50mm | 16mm | 12 |
| T4411 025 | 2.5mm | 56mm | 18mm | 12 |
| T4411 03 | 3.0mm | 63mm | 20mm | 12 |
| T4411 035 | 3.5mm | 67mm | 23mm | 12 |
| T4411 04 | 4.0mm | 71mm | 25mm | 12 |
| T4411 045 | 4.5mm | 75mm | 26mm | 12 |
| T4411 05 | 5.0mm | 80mm | 28mm | 12 |
| T4411 055 | 5.5mm | 85mm | 30mm | 12 |
| T4411 06 | 6.0mm | 90mm | 32mm | 12 |
| T4411 07 | 7.0mm | 95mm | 34mm | 12 |
| T4411 08 | 8.0mm | 100mm | 36mm | 12 |
| T4411 09 | 9.0mm | 105mm | 38mm | 12 |
| T4411 10 | 10.0mm | 112mm | 40mm | 12 |
| T4411 11 | 11.0mm | 118mm | 43mm | 12 |
| T4411 12 | 12.0mm | 125mm | 45mm | 6 |
| T4411 13 | 13.0mm | 133mm | 50mm | 6 |
| T4411 14 | 14.0mm | 140mm | 56mm | 3 |
| T4411 15 | 15.0mm | 147mm | 58mm | 3 |
| T4411 16 | 16.0mm | 154mm | 60mm | 3 |
| T4411 17 | 17.0mm | 160mm | 63mm | 3 |
| T4411 18 | 18.0mm | 170mm | 65mm | 3 |
| T4411 19 | 19.0mm | 180mm | 70mm | 3 |
| T4411 20 | 20.0mm | 187mm | 73mm | 3 |
| T4411 22 | 22.0mm | 200mm | 80mm | 3 |

- Supplied in a heavy duty nickel plated steel clip holder for convenience



Hexagon key folding sets - 7 Piece

| Item Number | Key Sizes | Count |
|-------------|--|-------|
| T4404A | Metric 2.5, 3, 4, 5, 6, 7, 8mm | 6 |
| T4405A | Imperial AF 3/32, 5/32, 3/16, 3/8, 1/4, 5/16, 1/8" | 6 |

- Supplied in a clip holder for convenience



TX tamperproof key folding set - 8 Piece

| Item Number | Key Sizes | Count |
|-------------|--|-------|
| T4407 | T06, T07, T08, T09, T10, T15, T20, T25 | 12 |

- Ball ended for use at an angle of up to 25° where access is restricted
- Supplied in a storage holder for convenience



Hexagon key clip set - 10 Piece ball end

| Item Number | Key Sizes | Count |
|-------------|--|-------|
| T4443M | Metric 1.5, 2, 2.5, 3, 4, 5, 6, 7, 8, 10mm | 6 |

- Ball ended for use at an angle of up to 25° where access is restricted
- Supplied in a storage holder for convenience



Hexagon key clip set - 9 Piece ball end

| Item Number | Key Sizes | Count |
|-------------|--|-------|
| T4444I | Imperial AF 5/64, 3/32, 1/8, 5/32, 3/16, 7/32, 1/4, 5/16, 3/8" | 6 |

- Supplied on a key ring for convenience



Hexagon key ring set - 8 Piece

ISO 2936

| Item Number | Key Sizes | Count |
|-------------|---|-------|
| T4414 | Imperial AF 1/16, 5/64, 3/32, 1/8, 5/32, 3/16, 7/32, 1/4" | 6 |
| T4417 | Metric 1.5, 2, 2.5, 3, 4, 5, 6, 7mm | 6 |

- Supplied on a key ring for convenience

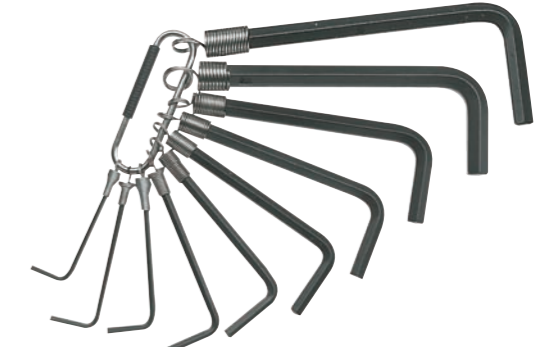

Hexagon key ring set - 10 Piece

ISO 2936

| Item Number | Key Sizes | Count |
|-------------|--|-------|
| T4415 | Imperial AF 1/16, 5/64, 3/32, 1/8, 5/32, 3/16, 7/32, 1/4, 5/16, 3/8" | 6 |
| T4416 | Metric 1.5, 2, 2.5, 3, 4, 5, 6, 7, 8, 10mm | 6 |

FILES

FEILEN
LIMES
LIMAS

106-107

WARDING & NEEDLE FILES

SCHLÜSSEL- & NADELFEILEN
LIMES DE SERRURIER ET À AIGUILLE
LIMAS DE PALETONES Y DE AGUJAS

108-109

HAMMERS

HÄMMER
MARTEAUX
MARTILLOS

109-110

PUNCHES

KÖRNER UND DURCHSCHLÄGE
POINTEAUX
PUNZONES

110

SNIPS

BLECHSCHEREN
CISEAUX ET CISAILLES
TIJERAS DE CHAPA

110

COMPOUND ACTION SNIPS

KOMBI BLECHSCHEREN
CISAILLES À ACTION COMPOSÉE
TIJERAS DE CHAPA COMPUESTAS

110

STUD EXTRACTORS

STEBBOLZENZIEHER
EXTRACTEURS DE GOUJONS
SACAESPIGAS

111

TAP & DIE SET

GEWINDESCHNEIDEISEN SATZ
JEU DE TARAUDS ET FILIÈRES
CONJUNTO DE TERRAJAS DE ROSCAS

111

WIRE BRUSH

DRAHTBÜRSTE
BROSSE MÉTALLIQUE
CEPILLO DE ALAMBRE

111

ENGINEER'S TOOLS

MECHANIKERWERKZEUGE
OUTILS MECHANICIQUES
HERRAMIENTAS DE MECÁNICO



FILES

FILES



1 Manufactured from special file steel, precision cut & hardened for outstanding performance and durability

2 Ergonomic, soft grip handle for superior comfort & control

3 Specially designed solid inner core for a safe & secure handle to tang bond



- One safe edge



Engineer's file - Flat bastard cut

| Item Number | Length | Icon | Quantity |
|-------------|-----------|------|----------|
| T0080B 10 | 250mm 10" | | 3 |

- One safe edge



Engineer's files - Flat second cut

| Item Number | Length | Icon | Quantity |
|-------------|-----------|------|----------|
| T0080 6 | 150mm 6" | | 3 |
| T0080 8 | 200mm 8" | | 3 |
| T0080 10 | 250mm 10" | | 3 |

- One safe edge



Engineer's files - Flat smooth cut

| Item Number | Length | Icon | Quantity |
|-------------|----------|------|----------|
| T0080S 6 | 150mm 6" | | 3 |
| T0080S 8 | 200mm 8" | | 3 |

- Tapered towards the point



Engineer's files - Half round second cut

| Item Number | Length | Icon | Quantity |
|-------------|-----------|------|----------|
| T0082 6 | 150mm 6" | | 3 |
| T0082 8 | 200mm 8" | | 3 |
| T0082 10 | 250mm 10" | | 3 |

- Tapered towards the point



Engineer's files - Round second cut

| Item Number | Length | Icon | Quantity |
|-------------|-----------|------|----------|
| T0083 6 | 150mm 6" | | 3 |
| T0083 8 | 200mm 8" | | 3 |
| T0083 10 | 250mm 10" | | 3 |

- 1 side bastard rasp
- 1 side bastard cut

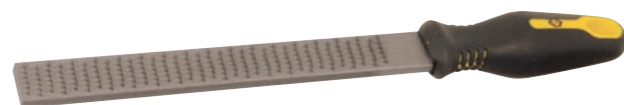

Combined file & rasp

| Item Number | Length | Icon | Quantity |
|-------------|----------|------|----------|
| T0106 06 | 150mm 6" | | 3 |
| T0106 08 | 200mm 8" | | 3 |

- Tapered towards the point



Wood rasp

| Item Number | Length | Icon | Quantity |
|-------------|----------|------|----------|
| T0107 06 | 150mm 6" | | 3 |
| T0107 08 | 200mm 8" | | 3 |

- Second cut



Chain saw files

| Item Number | Length | Ø | Icon | Quantity |
|-------------|-----------|-------------|------|----------|
| T0079 1 | 150mm 6" | 4mm 5/32" | | 3 |
| T0079 2 | 200mm 8" | 5mm 3/16" | | 3 |
| T0079 3 | 250mm 10" | 5.5mm 7/32" | | 3 |

- Tapered towards the point



Saw file - Standard

| Item Number | Length | Icon | Quantity |
|-------------|----------|------|----------|
| T0074 6 | 150mm 6" | | 3 |

- Tapered towards the point



Saw file - Slim

| Item Number | Length | Icon | Quantity |
|-------------|----------|------|----------|
| T0073 6 | 150mm 6" | | 3 |

- Tapered towards the point



Saw file - Extra slim

| Item Number | Length | Icon | Quantity |
|-------------|----------|------|----------|
| T0072 5 | 125mm 5" | | 3 |

- Flat profile
- Single cut



Mill saw file

| Item Number | Length | Icon | Quantity |
|-------------|-----------|------|----------|
| T0075 10 | 250mm 10" | | 3 |

CONTENTS: 3 x engineer's files, flat second cut, sizes: 150 & 200mm. 3 x engineer's files, flat smooth cut, sizes: 150 & 200mm. 3 x engineer's files, half round, sizes: 150 & 200mm. 3 x engineer's files, round, sizes: 150 & 200mm. 3 x file/rasps, sizes: 150 & 200mm. 3 x saw files, extra slim, size: 125mm. 3 x saw files, slim, size: 150mm. 3 x saw files, standard, size: 150mm. 3 x mill saw files, size: 250mm. 3 x chain saw files, sizes: 150 & 200mm.

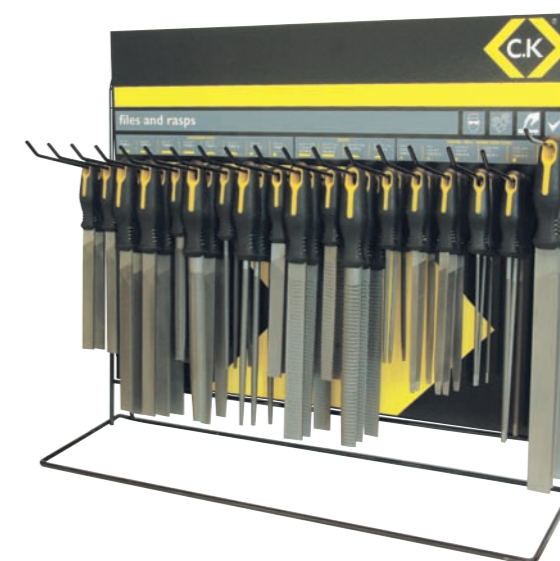

File display

| Item Number | Icon | Quantity |
|-------------|------|----------|
| T0098LS/1 | | 1 |

WARDING & NEEDLE FILES



Warding file - Flat second cut, square

| Item Number | 100mm 4" | i | 6 |
|-------------|----------|---|---|
| T0120 1 | 100mm 4" | | 6 |



Warding file - Flat second cut, tapered

| Item Number | 100mm 4" | i | 6 |
|-------------|----------|---|---|
| T0120 2 | 100mm 4" | | 6 |



Warding file - Half round second cut

| Item Number | 100mm 4" | i | 6 |
|-------------|----------|---|---|
| T0120 3 | 100mm 4" | | 6 |



Warding file - Round second cut

| Item Number | 100mm 4" | i | 6 |
|-------------|----------|---|---|
| T0120 4 | 100mm 4" | | 6 |



Warding file - Square second cut

| Item Number | 100mm 4" | i | 6 |
|-------------|----------|---|---|
| T0120 5 | 100mm 4" | | 6 |



Warding file - Triangular second cut

| Item Number | 100mm 4" | i | 6 |
|-------------|----------|---|---|
| T0120 6 | 100mm 4" | | 6 |



Warding file set - 6 Piece

| Item Number | 100mm 4" | i | 3 |
|-------------|----------|---|---|
| T0120P | 100mm 4" | | 3 |



Warding file set - 4 Piece

| Item Number | 100mm 4" | i | 3 |
|-------------|----------|---|---|
| T0119 | 100mm 4" | | 3 |



Needle file set - 6 Piece

| Item Number | i | 3 |
|-------------|---|---|
| T0124P | | 3 |

- Brass chuck securely grips the needle file shaft for safe use



Needle file handle

| Item Number | 95mm 3 3/4" | 6 |
|-------------|-------------|---|
| T0071 | 95mm 3 3/4" | 6 |

HAMMERS

- Drop forged high carbon steel head - hardened & tempered for superior strength and durability
- Black lacquered to protect against corrosion
- Tough hickory shaft for durability
- Ball pein for setting rivets



Ball pein hammers

| Item Number | | 3 |
|-------------|---------------|---|
| T4208H 08 | 227g 1/2 lb | 3 |
| T4208H 16 | 454g 1 lb | 3 |
| T4208H 24 | 682g 1 1/2 lb | 3 |
| T4208H 32 | 908g 2 lb | 3 |

- Drop forged high carbon steel head - hardened & tempered for superior strength and durability
- Black lacquered to protect against corrosion
- Traditional ash shaft for strength



Engineer's hammer - French pattern

| Item Number | 300g 10 1/2 oz | 12 |
|-------------|----------------|----|
| 356002 | 300g 10 1/2 oz | 12 |

- Drop forged high carbon steel head - hardened & tempered for superior strength and durability
- Black lacquered to protect against corrosion
- Traditional ash shaft for strength



Engineer's hammers - German pattern

DIN 1041

| Item Number | | 12 |
|-------------|----------------|----|
| T4227A 0100 | 100g 3 1/2 oz | 12 |
| T4227A 0200 | 200g 7 oz | 12 |
| T4227A 0300 | 300g 10 1/2 oz | 12 |
| T4227A 0500 | 500g 17 1/2 oz | 12 |
| T4227A 1000 | 1000g 35oz | 12 |

PUNCHES

- Hardened carbon steel with gun metal finish for protection
- Knurled shaft for grip



Centre punch - Round 10mm

| Item Number | 100mm 4" | 12 |
|-------------|----------|----|
| T3307P | 100mm 4" | 12 |

- High quality chrome vanadium steel hardened for durability



Centre punch - Octagonal 10mm

| Item Number | 150mm 6" | 6 |
|-------------|----------|---|
| T3319 | 150mm 6" | 6 |

- High quality chrome vanadium steel hardened for durability



Centre punch - Octagonal 12mm

| Item Number | 120mm 4 3/4" | 3 |
|-------------|--------------|---|
| T3326 | 120mm 4 3/4" | 3 |

- High quality chrome molybdenum steel hardened for durability



Parallel pin punches

DIN 6450

| Item Number | Length | Ø | Quantity |
|-------------|----------|-------------|----------|
| T3328 05 | 150mm 6" | 2mm 1/16" | 3 |
| T3328 06 | 150mm 6" | 2.5mm 3/32" | 3 |
| T3328 08 | 150mm 6" | 3mm 1/8" | 3 |
| T3328 10 | 150mm 6" | 4mm 1/4" | 3 |
| T3328 12 | 150mm 6" | 5mm 5/16" | 3 |
| T3328 14 | 150mm 6" | 5.5mm 7/32" | 3 |
| T3328 16 | 150mm 6" | 6mm 1/4" | 3 |
| T3328 20 | 150mm 6" | 8mm 5/16" | 3 |
| T3328 24 | 150mm 6" | 10mm 3/8" | 3 |



Parallel pin punch set - 6 Piece

DIN 6450

| Item Number | Ø | Quantity |
|-------------|-----------------------|----------|
| T3328S | 2, 2.5, 3, 4, 5 & 6mm | 1 |

SNIPS

- Forged alloy steel for strength & durability
- Hardened & tempered jaws for high cutting performance
- Stop pin to prevent finger nipping during use

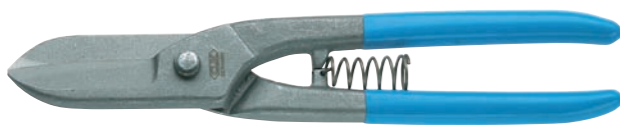

Tin snips

| Item Number | Length | Quantity |
|-------------|-----------|----------|
| T4536 08 | 200mm 8" | 3 |
| T4536 10 | 250mm 10" | 3 |

- Lightweight multipurpose cutter for paper, card, cloth, thin sheet metal, etc



Tuff snips

| Item Number | Length | Quantity |
|-------------|----------|----------|
| T4506 | 180mm 7" | 6 |

COMPOUND ACTION SNIPS

- Compound action, high leverage design for easy cutting of steel, stainless steel, titanium, etc
- Forged chrome molybdenum steel jaws, hardened and tempered for long term cutting performance
- Ergonomic grips with slip guards for safety



Compound action snips

| Item Number | Length | Direction | Quantity |
|-------------|-----------|-----------|----------|
| T4537AS | 240mm 10" | straight | 3 |



Compound action snips

| Item Number | Length | Direction | Quantity |
|-------------|-----------|-----------|----------|
| T4537AL | 240mm 10" | left | 3 |



Compound action snips

| Item Number | Length | Direction | Quantity |
|-------------|-----------|-----------|----------|
| T4537AR | 240mm 10" | right | 3 |

STUD EXTRACTORS

- Hardened chrome vanadium steel
- Left hand threaded for extracting broken studs and screws



Stud extractor set - 5 Piece

| Item Number | Quantity |
|-------------|----------|
| T3062 01 | 5 |

- Hardened chrome vanadium steel
- Left hand threaded for extracting broken studs and screws



Stud extractor set - 6 Piece

| Item Number | Quantity |
|-------------|----------|
| T3062 02 | 5 |

TAP & DIE SETS

- High carbon steel, hardened & tempered for strength and durability
- Precision machined to produce accurate thread forms

CONTENTS: Tap & dies, sizes: 3 x 0.5, 4 x 0.7, 5 x 0.8, 6 x 1.0, 7 x 1.0, 8 x 1.25, 10 x 1.5, 12 x 1.75mm & 1/8" NPT. Tap wrench. Die stock. Screwdriver.



Tap & die set - 21 Piece metric

| Item Number | Quantity |
|-------------|----------|
| T4032 | 6 |

WIRE BRUSH

- Hardened & tempered steel wire bristles, set in 4 rows for professional results



Wire brush

| Item Number | Length | Quantity |
|-------------|--------|----------|
| T6238 4 | 4 rows | 12 |

CONCRETE DRILL BITS

BETONBOHRER
 FORETS À BÉTON
 BROCAS PARA HORMIGÓN

114-115

BRICK DRILL BITS

STEINBOHRER
 FORETS À MAÇONNERIE
 BROCAS PARA LADRILLO

116

METAL DRILL BITS

METALLBOHRER
 FORETS À MÉTAUX
 BROCAS PARA PERFORACIÓN EN METAL

116-119

MULTIPURPOSE DRILL BITS

MEHRZWECKBOHRER
 FORETS UNIVERSELS
 BROCAS MULTIFUNCIÓN

119

FAST4

FAST4
 FAST4
 FAST4

120-121

WOOD DRILL BITS

HOLZBOHRER
 MÈCHES À BOIS
 BROCAS PARA MADERA

121-123

HOLESAWS

LOCHSÄGEN
 SCIES-CLOCHE
 PORTAPUNTAS

124-125

HOLESAW KITS

LOCHSÄGENSÄTZE
 JEUX DE SCIES-CLOCHE
 KITS DE PORTAPUNTAS

126

SCREWDRIVER BITS - STANDARD

SCHRAUBENDREHERBITS
 EMBOUTS DE VISSAGE
 PUNTAS DE DESTORNILLADOR

127-129

SCREWDRIVER BIT SETS

SCHRAUBENDREHERBITSÄTZE
 JEUX D'EMBOUTS DE VISSAGE
 CONJUNTOS DE PUNTAS DE DESTORNILLADOR

129-131

SCREWDRIVER BITS - TIN COATED

SCHRAUBENDREHERBITS - TIN-BESCHICHTET
 EMBOUTS DE VISSAGE - REVÊTEMENT TIN
 PUNTAS DE DESTORNILLADOR - GALVANIZADO

131-133

SCREWDRIVER BIT HOLDERS

SCHRAUBENDREHER-BITHALTER
 PORTE-EMBOUTS DE VISSAGE
 PORTAPUNTAS DE DESTORNILLADOR

134

JIGSAW BLADES

LAUBSÄGEBLÄTTER
 LAMES DE SCIE SAUTEUSE
 HOJAS DE SIERRA DE CALAR

134-135

POWER TOOL ACCESSORIES

ELEKTROWERKZEUGE - ZUBEHÖR
 ACCESSOIRES POUR OUTILS ÉLECTRIQUES
 ACCESORIOS PARA HERRAMIENTAS MOTORIZADAS



CONCRETE DRILL BITS

- Forged steel with tungsten carbide tip for durability
- Optimised design for high performance drilling of concrete & stone

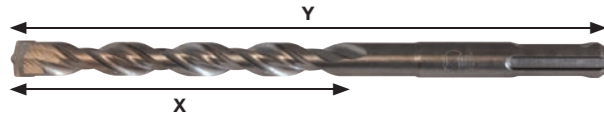

Concrete drill bits SDS-Plus

| Item Number | Ø | X | Y | 📦 |
|-------------|-------|-------|--------|---|
| T3140 0511 | 5mm | 50mm | 110mm | 6 |
| T3140 0516 | 5mm | 100mm | 160mm | 6 |
| T3140 05511 | 5.5mm | 50mm | 110mm | 6 |
| T3140 05516 | 5.5mm | 100mm | 160mm | 6 |
| T3140 0611 | 6mm | 50mm | 110mm | 6 |
| T3140 0616 | 6mm | 100mm | 160mm | 6 |
| T3140 0621 | 6mm | 150mm | 210mm | 6 |
| T3140 06511 | 6.5mm | 50mm | 110mm | 6 |
| T3140 06516 | 6.5mm | 100mm | 160mm | 6 |
| T3140 0711 | 7mm | 50mm | 110mm | 6 |
| T3140 0716 | 7mm | 100mm | 160mm | 6 |
| T3140 0811 | 8mm | 50mm | 110mm | 6 |
| T3140 0816 | 8mm | 100mm | 160mm | 6 |
| T3140 0821 | 8mm | 150mm | 210mm | 6 |
| T3140 0826 | 8mm | 200mm | 260mm | 6 |
| T3140 0845 | 8mm | 400mm | 450mm | 6 |
| T3140 1016 | 10mm | 100mm | 160mm | 6 |
| T3140 1021 | 10mm | 150mm | 210mm | 6 |
| T3140 1026 | 10mm | 200mm | 260mm | 6 |
| T3140 1045 | 10mm | 400mm | 450mm | 6 |
| T3140 1215 | 12mm | 100mm | 160mm | 6 |
| T3140 1221 | 12mm | 150mm | 210mm | 6 |
| T3140 1225 | 12mm | 200mm | 260mm | 6 |
| T3140 1245 | 12mm | 400mm | 450mm | 6 |
| T3140 12100 | 12mm | 950mm | 1000mm | 6 |
| T3140 1425 | 14mm | 200mm | 250mm | 6 |
| T3140 1445 | 14mm | 400mm | 450mm | 6 |
| T3140 1630 | 16mm | 250mm | 300mm | 6 |
| T3140 1645 | 16mm | 400mm | 450mm | 6 |
| T3140 16100 | 16mm | 950mm | 1000mm | 6 |
| T3140 1830 | 18mm | 250mm | 300mm | 6 |
| T3140 1845 | 18mm | 400mm | 450mm | 6 |
| T3140 2030 | 20mm | 250mm | 300mm | 6 |
| T3140 2045 | 20mm | 400mm | 450mm | 6 |
| T3140 20100 | 20mm | 950mm | 1000mm | 6 |
| T3140 2545 | 25mm | 400mm | 450mm | 6 |
| T3140 25100 | 25mm | 950mm | 1000mm | 6 |

CONTENTS: 1 x drill bit, sizes: 5 x 110, 6 x 110, 8 x 110, 6 x 150, 8 x 150, 10 x 150 & 12 x 150mm.



Concrete drill bits SDS-Plus set - 7 Piece

| Item Number | 📦 |
|-------------|---|
| T3144 | 1 |

CONTENTS: 6 x drill bits, sizes: 5.5 x 110, 5.5 x 160 & 7 x 160mm. 3 x drill bits, sizes: 6 x 110, 6 x 160, 8 x 160 & 10 x 160mm. 2 x drill bits, size: 10 x 210mm.



Concrete drill bits SDS-Plus - Top sellers display

| Item Number | i | 📦 |
|-------------|-----------------|---|
| T3140TSBOM | stock and stand | 1 |

CONTENTS: 6 x drill bits, sizes: 5.5 x 110, 5.5 x 160 & 7 x 160mm. 3 x drill bits, sizes: 6 x 110, 6 x 160, 6.5 x 160, 8 x 160, 8 x 260 & 10 x 160mm. 2 x drill bits, sizes: 5 x 110, 5 x 160, 6 x 210, 7 x 110, 8 x 210, 8 x 450, 10 x 210, 10 x 260, 10 x 450, 12 x 160, 12 x 210, 12 x 260, 12 x 450, 14 x 250 & 16 x 450mm.



Concrete drill bits SDS-Plus - Full range display

| Item Number | i | 📦 |
|-------------|-----------------|---|
| T3140RBOM | stock and stand | 1 |

- Forged steel with tungsten carbide tip for durability
- Optimised design for high performance drilling of concrete & stone

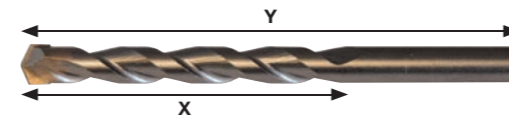

Concrete drill bits

| Item Number | Ø | X | Y | No. | 📦 |
|-------------|-------|------|-------|-----|----|
| T3066 04 | 4mm | 45mm | 75mm | 6 | 10 |
| T3066 05 | 5mm | 50mm | 85mm | 8 | 10 |
| T3066 055 | 5.5mm | 50mm | 85mm | 10 | 10 |
| T3066 06 | 6mm | 60mm | 100mm | 11 | 10 |
| T3066 065 | 6.5mm | 60mm | 100mm | 12 | 10 |
| T3066 07 | 7mm | 60mm | 100mm | 14 | 10 |
| T3066 08 | 8mm | 80mm | 100mm | 16 | 5 |
| T3066 10 | 10mm | 80mm | 120mm | 21 | 5 |
| T3066 12 | 12mm | 95mm | 150mm | C | 5 |
| T3066 13 | 13mm | 83mm | 150mm | 24 | 5 |
| T3066 14 | 14mm | 83mm | 150mm | 25 | 5 |
| T3066 16 | 16mm | 83mm | 150mm | 26 | 5 |

CONTENTS: 1 x drill bit, sizes: 4, 5.5, 6.5, 7 & 8mm.



Concrete drill bits set - 5 Piece

| Item Number | 📦 |
|-------------|---|
| T3068A | 1 |

CONTENTS: 9 x drill bits, size: 7mm. 6 x drill bits, sizes: 5 & 5.5mm. 4 x drill bits, sizes: 6, 6.5 & 8mm.



Concrete drill bits - Top sellers display

| Item Number | i | 📦 |
|-------------|-----------------|---|
| T3066TSBOM | stock and stand | 1 |

BRICK DRILL BITS

- Forged steel with tungsten carbide tip for durability
- Optimised design for fast & accurate drilling of brick type materials

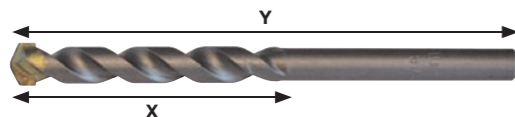

Brick drill bits

| Item Number | Ø | X | Y | |
|-------------|-------|-------|-------|---|
| T3071M 04 | 4mm | 38mm | 75mm | 5 |
| T3071M 05 | 5mm | 44mm | 85mm | 5 |
| T3071M 055 | 5.5mm | 44mm | 85mm | 5 |
| T3071M 06 | 6mm | 54mm | 100mm | 5 |
| T3071M 065 | 6.5mm | 54mm | 100mm | 5 |
| T3071M 07 | 7mm | 54mm | 100mm | 5 |
| T3071M 08 | 8mm | 67mm | 120mm | 5 |
| T3071M 10 | 10mm | 67mm | 120mm | 5 |
| T3071M 12 | 12mm | 85mm | 150mm | 5 |
| T3071M 13 | 13mm | 85mm | 150mm | 5 |
| T3071M 14 | 14mm | 85mm | 150mm | 5 |
| T3071M 16 | 16mm | 85mm | 150mm | 5 |
| T3069 055 | 5.5mm | 135mm | 200mm | 5 |
| T3069 06 | 6mm | 135mm | 200mm | 5 |
| T3069 065 | 6.5mm | 135mm | 200mm | 5 |
| T3069 07 | 7mm | 135mm | 200mm | 5 |
| T3069 08 | 8mm | 135mm | 200mm | 5 |
| T3069 10 | 10mm | 135mm | 200mm | 5 |
| T3069 12 | 12mm | 135mm | 200mm | 5 |
| T3069 14 | 14mm | 135mm | 200mm | 5 |

CONTENTS: 1 x drill bit, sizes: 4, 5.5, 6.5, 7 & 8mm.



Brick drill bits set - 5 Piece

| Item Number | |
|-------------|---|
| T3072A | 3 |

CONTENTS: 12 x drill bits, size: 7mm. 10 x drill bits, sizes: 5 & 5.5mm. 6 x drill bits, sizes: 6, 6.5 & 8mm.



Brick drill bits - Top sellers display

| Item Number | | |
|-------------|-----------------|---|
| T3071TSBOM | stock and stand | 1 |

METAL DRILL BITS

- Forged HSS, precision ground for accurate drilling



Metal drill bits - Imperial

| Item Number | Ø | X | Y | | |
|-------------|--------|-------|-------|-------------|----|
| T3180 06T | 1/16" | 20mm | 43mm | twin pack | 10 |
| T3180 07T | 5/64" | 24mm | 49mm | twin pack | 10 |
| T3180 09T | 3/32" | 30mm | 57mm | twin pack | 10 |
| T3180 10T | 7/64" | 33mm | 61mm | twin pack | 10 |
| T3180 12T | 1/8" | 36mm | 65mm | twin pack | 10 |
| T3180 14 | 9/64" | 39mm | 70mm | single pack | 10 |
| T3180 15 | 5/32" | 43mm | 75mm | single pack | 10 |
| T3180 17 | 11/64" | 47mm | 80mm | single pack | 10 |
| T3180 18 | 3/16" | 52mm | 86mm | single pack | 5 |
| T3180 21 | 7/32" | 57mm | 93mm | single pack | 5 |
| T3180 25 | 1/4" | 63mm | 101mm | single pack | 5 |
| T3180 28 | 9/32" | 69mm | 109mm | single pack | 5 |
| T3180 31 | 5/16" | 75mm | 117mm | single pack | 5 |
| T3180 37 | 3/8" | 87mm | 133mm | single pack | 5 |
| T3180 43 | 7/16" | 94mm | 142mm | single pack | 5 |
| T3180 50 | 1/2" | 101mm | 151mm | single pack | 5 |

- Forged HSS, precision ground for accurate drilling



Metal drill bits - Metric

| Item Number | Ø | X | Y | | |
|-------------|--------|------|-------|-------------|----|
| T3182 01T | 1mm | 12mm | 34mm | twin pack | 10 |
| T3099 01 | | | | loose | 10 |
| T3182 015T | 1.5mm | 18mm | 40mm | twin pack | 10 |
| T3099 015 | | | | loose | 10 |
| T3182 02T | 2mm | 24mm | 49mm | twin pack | 10 |
| T3099 02 | | | | loose | 10 |
| T3182 025T | 2.5mm | 30mm | 57mm | twin pack | 10 |
| T3099 025 | | | | loose | 10 |
| T3182 03T | 3mm | 33mm | 61mm | twin pack | 10 |
| T3099 03 | | | | loose | 10 |
| T3182 035T | 3.5mm | 39mm | 70mm | twin pack | 10 |
| T3099 035 | | | | loose | 10 |
| T3182 04T | 4mm | 43mm | 75mm | twin pack | 10 |
| T3099 04 | | | | loose | 10 |
| T3182 045 | 4.5mm | 47mm | 80mm | single pack | 10 |
| T3099 045 | | | | loose | 10 |
| T3182 05 | 5mm | 52mm | 86mm | single pack | 5 |
| T3099 05 | | | | loose | 10 |
| T3182 055 | 5.5mm | 57mm | 93mm | single pack | 5 |
| T3099 055 | | | | loose | 10 |
| T3182 06 | 6mm | 57mm | 93mm | single pack | 5 |
| T3099 06 | | | | loose | 10 |
| T3182 065 | 6.5mm | 63mm | 101mm | single pack | 5 |
| T3099 065 | | | | loose | 10 |
| T3182 07 | 7mm | 69mm | 109mm | single pack | 5 |
| T3099 07 | | | | loose | 10 |
| T3182 075 | 7.5mm | 69mm | 107mm | single pack | 5 |
| T3099 075 | | | | loose | 10 |
| T3182 08 | 8mm | 75mm | 117mm | single pack | 5 |
| T3099 08 | | | | loose | 10 |
| T3182 085 | 8.5mm | 75mm | 117mm | single pack | 5 |
| T3099 085 | | | | loose | 10 |
| T3182 09 | 9mm | 81mm | 125mm | single pack | 5 |
| T3099 09 | | | | loose | 10 |
| T3182 085 | 8.5mm | 75mm | 117mm | single pack | 5 |
| T3099 095 | | | | loose | 10 |
| T3182 10 | 10mm | 87mm | 133mm | single pack | 5 |
| T3099 10 | | | | loose | 10 |
| T3182 105 | 10.5mm | 87mm | 133mm | single pack | 5 |
| T3099 105 | | | | loose | 5 |
| T3182 11 | 11mm | 94mm | 142mm | single pack | 5 |
| T3099 11 | | | | loose | 5 |
| T3182 115 | 11.5mm | 94mm | 142mm | single pack | 5 |
| T3099 115 | | | | loose | 5 |

Continued in the next column

| | | | | | |
|-----------|--------|-------|-------|-------------|---|
| T3182 12 | 12mm | 101mm | 151mm | single pack | 5 |
| T3099 12 | | | | loose | 5 |
| T3182 125 | 12.5mm | 101mm | 151mm | single pack | 5 |
| T3099 125 | | | | loose | 5 |
| T3182 13 | 13mm | 101mm | 151mm | single pack | 5 |
| T3099 13 | | | | loose | 5 |

CONTENTS: 1 x drill bit, sizes: 1, 1.5, 2, 2.5, 3, 3.5, 4, 4.5, 5, 5.5, 6, 6.5, 7, 7.5, 8, 8.5, 9, 9.5 & 10mm.



Metal drill bits set - 19 Piece

| Item Number | |
|-------------|---|
| T3191 | 3 |

CONTENTS: 1 x drill bit, sizes: 1.5, 2, 2.5, 3, 3.2, 3.5, 4, 4.5, 4.8, 5, 5.5, 6 & 6.5mm.



Metal drill bits set - 13 Piece

| Item Number | |
|-------------|---|
| T3058 | 3 |

CONTENTS: 1 x drill bit, sizes: 2, 3, 4, 5, 6 & 8mm.



Metal drill bits set - 6 Piece

| | |
|--------------------|---|
| Item Number | |
| T3098-6 | 3 |

- Forged HSS, precision ground for accurate drilling
- Titanium nitride coated for extra wear protection

CONTENTS: 1 x drill bit, sizes: 1, 1.5, 2, 2.5, 3, 3.5, 4, 4.5, 5, 5.5, 6, 6.5, 7, 7.5, 8, 8.5, 9, 9.5 & 10mm.



Metal drill bits TiN coated set - 19 Piece

| | |
|--------------------|---|
| Item Number | |
| T3291 | 3 |

- Forged HSS, precision ground for accurate drilling
- Titanium nitride coated for extra wear protection

CONTENTS: 1 x drill bit, sizes: 2, 3, 4, .5, 6 & 8mm.



Metal drill bits TiN coated set - 6 Piece

| | |
|--------------------|---|
| Item Number | |
| T3293 | 3 |

CONTENTS: 8 x drill bits, twin pack, sizes: 3 & 3.5mm. 6 x drill bits, twin pack, sizes: 2.5 & 4mm. 8 x drill bits, size: 5mm. 3 x drill bits, size: 6mm.



Metal drill bits, metric - Top sellers display

| | |
|--------------------|-------------------|
| Item Number | |
| T3182SBOM | stock and stand 1 |

CONTENTS: 8 x drill bits, twin packs, sizes: 3 & 3.5mm. 6 x drill bits, twin packs, sizes: 1, 1.5, 2, 2.5 & 4mm. 8 x drill bits, size: 5mm. 6 x drill bits, sizes: 4.5 & 5.5mm. 3 x drill bits, sizes: 6, 6.5, 7, 8, 9, 10, 12 & 13mm.



Metal drill bits, metric - Full range display

| | |
|--------------------|-------------------|
| Item Number | |
| T3182RBOM | stock and stand 1 |

- HSS, precision ground for accurate drilling
- Dual flute construction for faster drilling & longer life



Multistep drill bits

| | |
|--------------------|---|
| Item Number | |
| T3008 | 6, 9, 12.3, 15.2, 18.6, 20.4, 22.5, 25.4, 28.3 & 30.5mm 1 |
| T3010 2 | 6, 8, 10, 12, 14, 16, 18, 20, 22, 24, 28 & 30mmØ 1 |
| T3009 | 4, 5, 6, 7, 8, 9, 10, 11 & 12mmØ 1 |
| T3010 1 | 4, 6, 8, 10, 12, 14, 16, 18 & 20mmØ 1 |

MULTIPURPOSE DRILL BITS

CONTENTS: 1 x brick drill bit, sizes: 4, 5.5, 6.5, 7 & 8mm. 1 x metal drill bit, sizes: 2, 3, 4, 5, 6 & 8mm. 1 x wood drill bit, sizes: 4, 5, 6, 8 & 10mm.

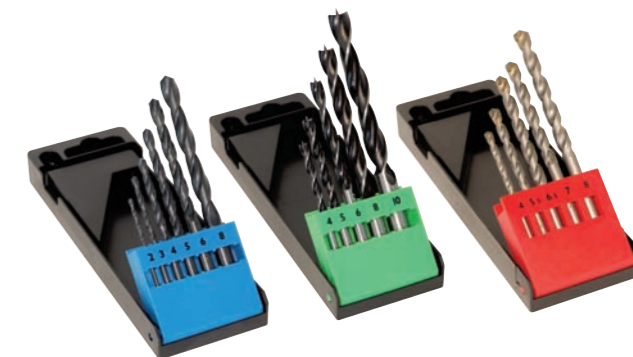

Brick, metal & wood drill bit set - 16 Piece

| | |
|--------------------|---|
| Item Number | |
| T3064A | 3 |

- Tungsten carbide tipped drills specially designed for drilling through concrete, brick, cement, stone, metal & ceramics

CONTENTS: 1 x drill bit, sizes: 4, 5, 6, 8 & 10mm.

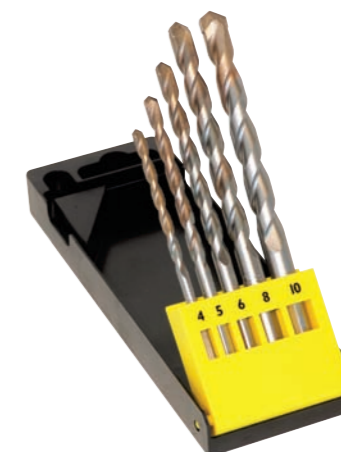

Universal drill bit set - 5 Piece

| | |
|--------------------|---|
| Item Number | |
| T3063 | 3 |

- Titanium nitride coated HSS for strength and durability
- Drills and cuts to create any size shape or hole
- Cuts through wood/plastic up to 5mm, aluminium up to 4mm and metal up to 3mm thick



Drill saw

| | |
|--------------------|--------|
| Item Number | |
| T3193T | 6mm 20 |

FAST4

4 FLUTES = FASTER DRILLING
4 SCHNEIDEN = SCHNELLERES BOHREN
4 LAMES = PERÇAGE PLUS RAPIDE
4 FLAUTAS = PERFORACIÓN MÁS RÁPIDA



1 4 blades offering 100% more cutting blade than a flat bit for faster drilling

4 Schneiden bieten für schnelleres Bohren doppelt soviel Kapazität als ein Flachbohrer

4 lames offrant 100 % de tranchants en plus par rapport aux mèches plates, pour un perçage plus rapide

4 hojas que permiten disponer de un 100% más de corte que con un trépano plano, para una perforación más rápida

2 Optimised flute geometry for faster waste removal

Optimierte Geometrie der Spannuten für schnelleres Entfernen der Späne

Géométrie optimisée des cannelures pour un enlèvement plus rapide des copeaux

Geometría escalonada y optimizada para conseguir una eliminación más rápida de los residuos

3 Precision ground cutting edges with outer spur blades for a smoother cut & cleaner breakout

Präzise geschliffene Schneidkanten mit äußeren Führungsschneiden für glatte Bohrlöcher mit sauberem Durchbruch

Arêtes coupantes à rectification de précision avec lames extérieures en pointe pour une coupe plus lisse et un débouchage plus propre

Bordes de corte con amolado de precisión, con hojas externas de rebarbado para un inicio más limpio y más suave del corte

4 Screw point allows accurate positioning & pulls the bit through with less effort

Schraubspitze ermöglicht genaues Ansetzen und einfache Führung beim Bohren

La pointe de centrage à vis permet un positionnement précis et entraîne la mèche avec moins d'efforts

Punta de tornillo que permite un posicionamiento preciso y hacer pasar el trépano con menos esfuerzo



Fast4

FAST4

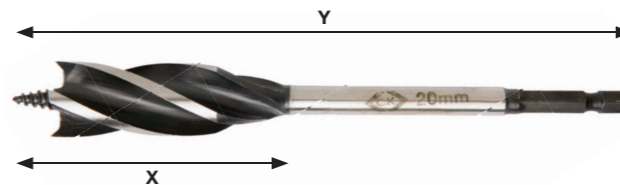

Fast4 drill bits

| Item Number | Ø | X | Y | 📦 |
|-------------|------|-------|-------|----|
| T2943-16 | 16mm | 110mm | 160mm | 10 |
| T2943-20 | 20mm | 110mm | 160mm | 10 |
| T2943-22 | 22mm | 110mm | 160mm | 10 |
| T2943-25 | 25mm | 110mm | 160mm | 10 |
| T2943-32 | 32mm | 110mm | 160mm | 10 |

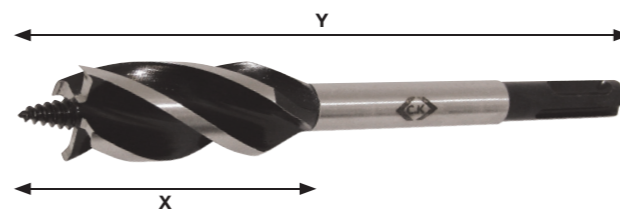

Fast4 drill bits SDS-Plus

| Item Number | Ø | X | Y | 📦 |
|-------------|------|-------|-------|----|
| T2944-16 | 16mm | 110mm | 160mm | 10 |
| T2944-20 | 20mm | 110mm | 160mm | 10 |
| T2944-22 | 22mm | 110mm | 160mm | 10 |
| T2944-25 | 25mm | 110mm | 160mm | 10 |
| T2944-32 | 32mm | 110mm | 160mm | 10 |

CONTENTS: 5 x drill bits, size: 25mm. 3 x drill bits, size: 20mm. 2 x drill bits, sizes: 16, 22 & 32mm.



Fast4 drill bits - Full range displays

| Item Number | i | i | 📦 |
|-------------|----------|-----------------|---|
| T2943RBOM | standard | stock and stand | 1 |
| T2944RBOM | SDS-Plus | stock and stand | 1 |

WOOD DRILL BITS

- Chrome vanadium steel for long life performance
- Brad pointed for accurate drill starts
- Spur ground external edge for clean hole cutting

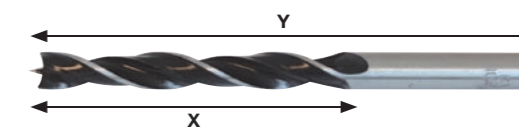

Wood drill bits

| Item Number | Ø | X | Y | 📦 |
|-------------|------|-------|-------|----|
| T3035 03 | 3mm | 33mm | 61mm | 10 |
| T3035 04 | 4mm | 43mm | 75mm | 10 |
| T3035 05 | 5mm | 52mm | 86mm | 5 |
| T3035 06 | 6mm | 60mm | 97mm | 5 |
| T3035 08 | 8mm | 75mm | 117mm | 5 |
| T3035 10 | 10mm | 87mm | 133mm | 5 |
| T3035 12 | 12mm | 96mm | 151mm | 5 |
| T3035 13 | 13mm | 96mm | 151mm | 5 |
| T3035 14 | 14mm | 97mm | 151mm | 5 |
| T3035 16 | 16mm | 100mm | 160mm | 3 |

CONTENTS: 1 x drill bit, sizes: 4, 5, 6, 8 & 10mm.

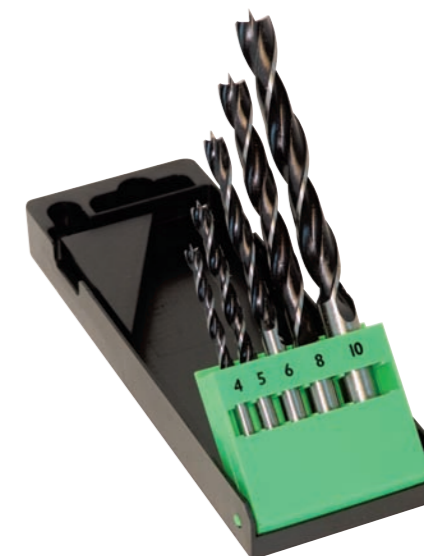

Wood drill bits set - 5 Piece

| Item Number | 📦 |
|-------------|---|
| T3040 | 3 |

CONTENTS: 6 x drill bits, sizes: 3, 4 & 5mm. 3 x drill bits, sizes: 6, 8 & 10mm.



Wood drill bits - Top sellers display

| Item Number | i | |
|-------------|-----------------|---|
| T3035TSBOM | stock and stand | 1 |

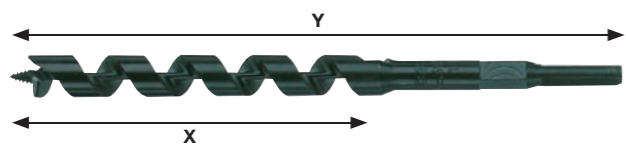

Auger bits - Standard

| Item Number | Ø | X | Y | |
|-------------|------|-------|-------|---|
| T3031 06 | 6mm | 90mm | 160mm | 6 |
| T3031 08 | 8mm | 100mm | 170mm | 6 |
| T3031 10 | 10mm | 120mm | 190mm | 6 |
| T3031 13 | 13mm | 120mm | 190mm | 6 |
| T3031 16 | 16mm | 130mm | 200mm | 6 |
| T3031 20 | 20mm | 140mm | 210mm | 6 |
| T3031 22 | 22mm | 140mm | 210mm | 6 |
| T3031 25 | 25mm | 140mm | 210mm | 6 |
| T3031 30 | 30mm | 140mm | 210mm | 6 |
| T3031 32 | 32mm | 140mm | 210mm | 6 |

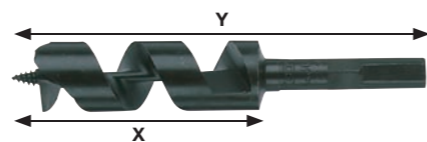

Auger bits - Short

| Item Number | Ø | X | Y | |
|-------------|------|------|-------|---|
| T3033 13 | 13mm | 50mm | 100mm | 6 |
| T3033 16 | 16mm | 70mm | 120mm | 6 |
| T3033 20 | 20mm | 80mm | 130mm | 6 |
| T3033 22 | 22mm | 80mm | 130mm | 6 |
| T3033 25 | 25mm | 80mm | 130mm | 6 |
| T3033 32 | 32mm | 80mm | 140mm | 6 |

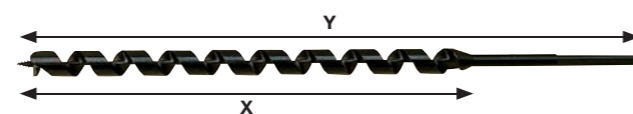

Auger bits - Long

| Item Number | Ø | X | Y | |
|-------------|------|-------|-------|---|
| T3034 10 | 10mm | 220mm | 300mm | 6 |
| T3034 13 | 13mm | 220mm | 300mm | 6 |
| T3034 16 | 16mm | 220mm | 300mm | 6 |
| T3034 20 | 20mm | 220mm | 300mm | 6 |
| T3034 22 | 22mm | 220mm | 300mm | 6 |
| T3034 25 | 25mm | 220mm | 300mm | 6 |

CONTENTS: 2 x auger bits, sizes: 10, 20 & 25mm. 1 x auger bit, sizes: 13, 16 & 22mm.



Auger bits, standard - Top sellers display

| Item Number | i | |
|-------------|-----------------|---|
| T3031TSBOM | stock and stand | 1 |

- HSS, hardened for long life performance
- Brad pointed for accurate drill starts
- Ground wing spur for clean hole cutting
- Quick lock direct E6.3 drive

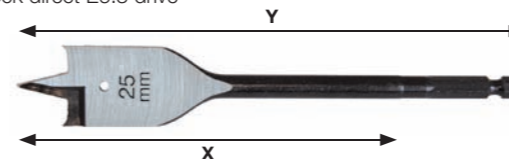

Flat bits - standard

| Item Number | Ø | X | Y | |
|-------------|------|-------|-------|---|
| T2942-06 | 6mm | 130mm | 160mm | 5 |
| T2942-08 | 8mm | 130mm | 160mm | 5 |
| T2942-10 | 10mm | 130mm | 160mm | 5 |
| T2942-12 | 12mm | 130mm | 160mm | 5 |
| T2942-13 | 13mm | 130mm | 160mm | 5 |
| T2942-14 | 14mm | 130mm | 160mm | 5 |
| T2942-16 | 16mm | 130mm | 160mm | 5 |
| T2942-20 | 20mm | 130mm | 160mm | 5 |
| T2942-22 | 22mm | 130mm | 160mm | 5 |
| T2942-25 | 25mm | 130mm | 160mm | 5 |
| T2942-28 | 28mm | 130mm | 160mm | 5 |
| T2942-32 | 32mm | 130mm | 160mm | 5 |
| T2942-38 | 38mm | 130mm | 160mm | 5 |

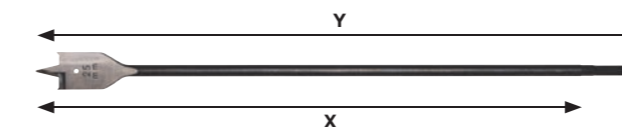

Flat bits - long

| Item Number | Ø | X | Y | |
|-------------|------|-------|-------|---|
| T2942-12400 | 12mm | 370mm | 400mm | 5 |
| T2942-16400 | 16mm | 370mm | 400mm | 5 |
| T2942-20400 | 20mm | 370mm | 400mm | 5 |
| T2942-25400 | 25mm | 370mm | 400mm | 5 |
| T2942-32400 | 32mm | 370mm | 400mm | 5 |

- Extension drive shaft for flat bits with E6.3 drive



Flat bits extension drive - Quick lock

| Item Number | | |
|-------------|-------|---|
| T2940-2 | 300mm | 5 |

CONTENTS: 1 x flat bit, sizes: 10, 13, 16, 20, 22 & 25mm.



Flat bits set - 6 Piece

| Item Number | |
|-------------|---|
| T2942P | 5 |

- HSS, hardened for long life performance



Countersink bits

| Item Number | | |
|-------------|----------|---|
| T2601S 3760 | 10 x 90° | 6 |
| T2601S 5090 | 13 x 90° | 6 |

CONTENTS: 3 x flat bits, sizes: 20 & 25mm. 2 x flat bits, sizes: 13, 16 & 22mm. 1 x flat bit, size: 32mm.



Flat bits, standard - Top sellers display

| Item Number | i | |
|-------------|-----------------|---|
| T2942TSBOM | stock and stand | 1 |

HOLESAWS

- HSS bi-metal holesaw with hardened vari-pitch teeth for the fast clean cutting of metal, wood, plastic & composite materials



Holesaws

| Item Number | Ø | |
|-------------|---------------|----|
| 424001 | 16mm 5/8" | 10 |
| 424002 | 19mm 3/4" | 10 |
| 424003 | 20mm 29/32" | 10 |
| 424005 | 22mm 7/8" | 10 |
| 424006 | 25mm 1" | 10 |
| 424007 | 29mm 1 1/8" | 10 |
| 424008 | 32mm 1 1/4" | 10 |
| 424010 | 38mm 1 1/2" | 10 |
| 424011 | 40mm 1 9/16" | 10 |
| 424012 | 41mm 1 5/8" | 10 |
| 424013 | 43mm 1 11/16" | 10 |
| 424014 | 44mm 1 3/4" | 10 |
| 424015 | 48mm 1 7/8" | 10 |
| 424016 | 51mm 2" | 10 |
| 424017 | 54mm 2 1/8" | 10 |
| 424018 | 57mm 2 1/4" | 10 |
| 424019 | 60mm 2 3/8" | 10 |
| 424020 | 64mm 2 1/2" | 10 |
| 424021 | 65mm 2 9/16" | 10 |
| 424022 | 67mm 2 5/8" | 10 |
| 424024 | 70mm 2 3/4" | 10 |
| 424025 | 73mm 2 7/8" | 10 |
| 424026 | 76mm 3" | 10 |
| 424027 | 79mm 3 1/8" | 10 |
| 424028 | 83mm 3 1/4" | 10 |
| 424029 | 86mm 3 3/8" | 10 |
| 424030 | 89mm 3 1/2" | 10 |
| 424031 | 92mm 3 5/8" | 10 |
| 424032 | 95mm 3 3/4" | 10 |
| 424033 | 102mm 4" | 10 |
| 424034 | 105mm 4 1/8" | 10 |
| 424035 | 111mm 4 3/8" | 10 |
| 424036 | 114mm 4 1/2" | 10 |

HOLESAW ARBORS & ACCESSORIES

- For use with holesaws up to 30mm
- Supplied with replaceable 1/4" HSS pilot drill



Arbor - For 14-30mm holesaws

| Item Number | Ø | |
|-------------|------------|----|
| 424037 | 8mm 5/16" | 10 |
| 424038 | 11mm 7/16" | 10 |

- For use with holesaws up to 30mm
- Supplied with replaceable 1/4" HSS pilot drill



Arbor SDS-Plus - For 14-30mm holesaws

| Item Number | | |
|-------------|--|----|
| 424047 | | 10 |

- Quick-release mechanism for fast holesaw interchange
- For use with holesaws from 32mm - 114mm
- Supplied with replaceable 1/4" HSS pilot drill



Arbor quick release - For 32-114mm holesaws

| Item Number | Ø | |
|-------------|------------|----|
| 424039 | 11mm 7/16" | 10 |

- Quick-release mechanism for fast holesaw interchange
- For use with holesaws up to 33mm
- Supplied with replaceable 1/4" HSS pilot drill



Arbor SDS-Plus quick release - For 32-114mm holesaws

| Item Number | | |
|-------------|--|----|
| 424048 | | 10 |

- For use with holesaws from 32mm - 114mm
- Supplied with replaceable 1/4" HSS pilot drill



Arbor locking - For 32-114mm holesaws

| Item Number | Ø | |
|-------------|------------|----|
| 424040 | 11mm 7/16" | 10 |

- For use with all 11mm hexagonal shaft arbors



300mm Extension Drive - For 11mm arbor

| Item Number | Ø | Length | |
|-------------|------------|--------|----|
| 424049 | 11mm 7/16" | 300mm | 10 |

- Replacement HSS pilot drill bit for holesaw arbor 424037, 424047 & 424048



Replacement pilot drill

| Item Number | | |
|-------------|--|----|
| 424041 | | 10 |

- Replacement HSS pilot drill bit for holesaw arbor 424038, 424039 & 424040



Replacement pilot drill

| Item Number | | |
|-------------|--|----|
| 424042 | | 10 |

CONTENTS: 1 x holesaw, sizes: 16, 19, 20, 22, 25, 29, 32, 38, 40, 44, 48, 51, 54, 57, 60, 64, 65, 67, 70, 73, 76, 79, 83, 89, 92, 95, 102, 105, 111 & 114mm. 1 x arbor 14-30mm (8mm shaft). 1 x arbor 14-30mm (11mm shaft). 1 x quick release arbor 32-114mm (11mm shaft). 1 x locking arbor 32-114mm (11mm shaft). 1 x SDS arbor 14-30mm. 1 x SDS quick release arbor 32-114mm. 1 x replacement pilot drill (for 424037, 424047 & 424048). 1 x replacement pilot drill (for 424038, 424039 & 424040). 1 x extension drive.



Holesaws & accessories - Range display

| Item Number | i | |
|-------------|-----------------|---|
| 400002 | stock and stand | 1 |



HOLESAW KITS

CONTENTS: 1 x holesaw, sizes: 16, 20, 25, 32, 38 & 51mm. Arbor 14-30mm (8mm shaft). Quick release arbor 32-114mm (11mm shaft). Hexagon key 4mm.



Holesaw kit -
9 Piece electrician

| Item Number | |
|-------------|---|
| 424045 | 1 |

CONTENTS: 1 x holesaw, sizes: 65, 70, 76 & 83mm. Quick release arbor 32-114mm (11mm shaft). Hexagon key 4mm.



Holesaw kit -
6 Piece downlight

| Item Number | |
|-------------|---|
| 424046 | 1 |

CONTENTS: 1 x holesaw, sizes: 22, 29, 35, 44, 51 & 64mm. Arbor 14-30mm (8mm shaft). Locking arbor 32-114mm (11mm shaft). Hexagon key 4mm.



Holesaw kit -
9 Piece

| Item Number | |
|-------------|---|
| 424043 | 1 |

CONTENTS: 1 x holesaw, sizes: 40, 54, 65, 67 & 68mm. Quick release arbor 32-114mm (11mm shaft).



Holesaw kit -
6 Piece

| Item Number | |
|-------------|---|
| 424044 | 1 |

SCREWDRIVER BITS - STANDARD

- Premium quality chrome vanadium steel for exceptional strength & durability
- Precision machined tip for an exact screw fit & damage free screwdriving

featuring GRIP-TIP technology



SCREWDRIVER BITS

1 GRIP-TIP™ anti cam-out ribs reduce the risk of slipping



DIN 3126-C6,3
ISO 1173 Drive

DIN 3126-E6,3
ISO 1173 Drive

featuring GRIP-TIP technology

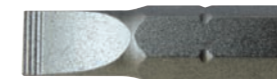

Screwdriver bits - Slotted

DIN ISO 1173

| Item Number | | | | |
|-------------|------|-------------|-------------|----|
| T4550-0645T | 25mm | 0.6 x 4.5mm | carded pair | 5 |
| T4550 0645 | | | loose | 10 |
| T4550-0855T | 25mm | 0.8 x 5.5mm | carded pair | 5 |
| T4550 0855 | | | loose | 10 |
| T4550-1055T | 25mm | 1.0 x 5.5mm | carded pair | 5 |
| T4550 1055 | | | loose | 10 |
| T4550-1265T | 25mm | 1.2 x 6.5mm | carded pair | 5 |
| T4550 1265 | | | loose | 10 |

featuring GRIP-TIP technology



Screwdriver bits - PZ

DIN ISO 1173

| Item Number | | | | |
|-------------|------|-----|-------------|----|
| T4562 1 | 25mm | PZ1 | carded pair | 25 |
| T4552 1 | | | loose | 10 |
| T4562 2 | 25mm | PZ2 | carded pair | 25 |
| T4552 2 | | | loose | 10 |
| T4562 3 | 25mm | PZ3 | carded pair | 25 |
| T4552 3 | | | loose | 10 |
| T4562 4 | 25mm | PZ4 | carded pair | 25 |
| T4552 4 | | | loose | 10 |



Screwdriver bits - PZ box of 15

DIN ISO 1173

| Item Number | | | |
|-------------|------|-----|---|
| T4562-215 | 25mm | PZ2 | 6 |



Screwdriver bits - PZ counterbox of 12

DIN ISO 1173

| Item Number | | | |
|-------------|------|-----|---|
| T4562-2CB | 25mm | PZ2 | 1 |



featuring GRIP-TIP technology



Screwdriver bits - PH

DIN ISO 1173

| Item Number | Length | Size | Configuration | Quantity |
|-------------|--------|------|---------------|----------|
| T4561 1 | 25mm | PH1 | carded pair | 5 |
| T4551 1 | 25mm | | loose | 10 |
| T4561 2 | 25mm | PH2 | carded pair | 5 |
| T4551 2 | 25mm | | loose | 10 |
| T4561 3 | 25mm | PH3 | carded pair | 5 |
| T4551 3 | 25mm | | loose | 10 |



Screwdriver bits - Robertson

DIN ISO 1173

| Item Number | Length | Size | Configuration | Quantity |
|-------------|--------|------|---------------|----------|
| T4553 1 | 25mm | 1 | | 10 |
| T4553 2 | 25mm | 2 | | 10 |
| T4553 3 | 25mm | 3 | | 10 |



Screwdriver bits - Hexagon

DIN ISO 1173

| Item Number | Length | Size | Configuration | Quantity |
|-------------|--------|-------|---------------|----------|
| T4554 25 | 25mm | 2.5mm | loose | 10 |
| T4554-3T | 25mm | 3.0mm | carded pair | 5 |
| T4554 3 | | | loose | 10 |
| T4554-4T | 25mm | 4.0mm | carded pair | 5 |
| T4554 4 | | | loose | 10 |
| T4554-5T | 25mm | 5.0mm | carded pair | 5 |
| T4554 5 | | | loose | 10 |
| T4554-6T | 25mm | 6.0mm | carded pair | 5 |
| T4554 6 | | | loose | 10 |



Screwdriver bits - TX

DIN ISO 1173

| Item Number | Length | Size | Configuration | Quantity |
|-------------|--------|------|---------------|----------|
| T4557-05T | 25mm | TX05 | carded pair | 5 |
| T4557 05 | | | loose | 10 |
| T4557-06T | 25mm | TX06 | carded pair | 5 |
| T4557 06 | | | loose | 10 |
| T4557-07T | 25mm | TX07 | carded pair | 5 |
| T4557 07 | | | loose | 10 |
| T4557-08T | 25mm | TX08 | carded pair | 5 |
| T4557 08 | | | loose | 10 |
| T4557-09T | 25mm | TX09 | carded pair | 5 |
| T4557 09 | | | loose | 10 |
| T4557-10T | 25mm | TX10 | carded pair | 5 |
| T4557 10 | | | loose | 10 |
| T4557-15T | 25mm | TX15 | carded pair | 5 |
| T4557 15 | | | loose | 10 |
| T4557-20T | 25mm | TX20 | carded pair | 5 |
| T4557 20 | | | loose | 10 |
| T4557-25T | 25mm | TX25 | carded pair | 5 |
| T4557 25 | | | loose | 10 |
| T4557-27T | 25mm | TX27 | carded pair | 5 |
| T4557 27 | | | loose | 10 |
| T4557-30T | 25mm | TX30 | carded pair | 5 |
| T4557 30 | | | loose | 10 |
| T4557-40T | 25mm | TX40 | carded pair | 5 |
| T4557 40 | | | loose | 10 |



Screwdriver bits - TX tamperproof

DIN ISO 1173

| Item Number | Length | Size | Configuration | Quantity |
|-------------|--------|------|---------------|----------|
| T4557T-10T | 25mm | TX10 | carded pair | 5 |
| T4557T 10 | | | loose | 10 |
| T4557T-15T | 25mm | TX15 | carded pair | 5 |
| T4557T 15 | | | loose | 10 |
| T4557T-20T | 25mm | TX20 | carded pair | 5 |
| T4557T 20 | | | loose | 10 |
| T4557T-25T | 25mm | TX25 | carded pair | 5 |
| T4557T 25 | | | loose | 10 |
| T4557T-30T | 25mm | TX30 | carded pair | 5 |
| T4557T 30 | | | loose | 10 |

featuring GRIP-TIP technology



Screwdriver bits - PZ long

DIN ISO 1173

| Item Number | Length | Size | Configuration | Quantity |
|-------------|--------|------|---------------|----------|
| T4556-1T | 50mm | PZ1 | carded pair | 5 |
| T4556 1 | | | loose | 10 |
| T4556-2T | 50mm | PZ2 | carded pair | 5 |
| T4556 2 | | | loose | 10 |

featuring GRIP-TIP technology



Screwdriver bits - PH long

DIN ISO 1173

| Item Number | Length | Size | Configuration | Quantity |
|-------------|--------|------|---------------|----------|
| T4555-1T | 50mm | PH1 | carded pair | 5 |
| T4555 1 | | | loose | 10 |
| T4555-2T | 50mm | PH2 | carded pair | 5 |
| T4555 2 | | | loose | 10 |



Screwdriver bits - Modulo

| Item Number | Size | Configuration | Quantity |
|-------------|-------|---------------|----------|
| 422001 | 1 & 2 | carded pair | 10 |
| T4545 1 | 1 | loose | 20 |
| T4545 2 | 2 | loose | 20 |

featuring GRIP-TIP technology



Screwdriver bits - PZ/slotted

| Item Number | Length | Size | Configuration | Quantity | |
|-------------|--------|------|---------------|-------------|---|
| T4579-1T | 50mm | PZ1 | 4mm | carded pair | 5 |
| T4579-2T | 50mm | PZ2 | 7mm | carded pair | 5 |

CONTENTS: Screwdriver bit holder. 5 x screwdriver bits, carded pairs, PZ size: 2 x 25mm. 3 x screwdriver bits, carded pairs, PZ sizes: 1 x 25, 2 x 50 & 3 x 25mm. 1 x screwdriver bits, box of 15, PZ, size: 2.



Screwdriver bits - Top sellers display

| Item Number | Configuration | Quantity |
|-------------|-----------------|----------|
| T4562TSBOM | stock and stand | 1 |

SCREWDRIVER BIT SETS

CONTENTS: Screwdriver bit holder. 1 x screwdriver bits, slotted, sizes: 3, 4, 4.5, 5, 5.5, 6, 7, 8 & 9mm; PZ, sizes: 0, 1, 2 & 3; PH, sizes: 0, 1, 2, & 3; TX, sizes: 8, 10, 15, 20, 25, 27, 30 & 40; Hexagon, sizes: 1.5, 2, 2.5, 3, 4, 5, 5.5 & 6mm.



Screwdriver bit clip set - 33 Piece

DIN ISO 1173

| Item Number | Quantity |
|-------------|----------|
| T4520 | 6 |

CONTENTS: 1 x screwdriver bit, slotted, sizes: 3, 4, 4.5, 5, 6, 7, 8 & 9mm.

featuring GRIP-TIP technology

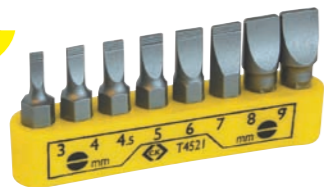

Screwdriver bit clip set - 8 Piece slotted

| | |
|-------------|---|
| Item Number | |
| T4521 | 6 |

CONTENTS: 1 x screwdriver bit, PZ, sizes: 0, 1, 2 & 3; PH, sizes: 0, 1, 2 & 3.

featuring GRIP-TIP technology



Screwdriver bit clip set - 8 Piece PH/PZ

| | |
|-------------|---|
| Item Number | |
| T4522 | 6 |

CONTENTS: 1 x screwdriver bit, TX, sizes: 8, 10, 15, 20, 25, 27, 30 & 40.



Screwdriver bit clip set - 8 Piece TX

| | |
|-------------|---|
| Item Number | |
| T4523 | 6 |

CONTENTS: 1 x screwdriver bit, TX tamperproof, sizes: 8, 10, 15, 20, 25, 27, 30 & 40.



Screwdriver bit clip set - 8 Piece TX tamperproof

| | |
|-------------|---|
| Item Number | |
| T4527 | 6 |

CONTENTS: 1 x screwdriver bit, hexagon, sizes: 1.5, 2, 2.5, 3, 4, 5, 5.5 & 6mm.



Screwdriver bit clip set - 8 Piece hexagon

| | |
|-------------|---|
| Item Number | |
| T4524 | 6 |

CONTENTS: 1 x screwdriver bit, hexagon tamperproof, sizes: 2, 2.5, 3, 4, 5, 5.5, 6 & 7mm.



Screwdriver bit clip set - 8 Piece hexagon tamperproof

| | |
|-------------|---|
| Item Number | |
| T4528 | 6 |

CONTENTS: 1 x screwdriver bit, slotted, sizes: 4.5 & 7mm; PZ, sizes: 1, 2 & 3; PH, sizes: 1, 2 & 3; TX, sizes: 15 & 20.

featuring GRIP-TIP technology



Screwdriver bit clip set - 10 Piece SL/PH/PZ/TX

| | | |
|-------------|-------|---|
| Item Number | | |
| T4525 | 100mm | 6 |

CONTENTS: Screwdriver bit holder. 1 x screwdriver bit, slotted, sizes: 4.5, 5.5, 6.5mm; TX, sizes: 10, 15, 20, 25, 30 & 40; Hexagon, sizes: 3, 4 & 5mm. 3 x screwdriver bits, PZ, sizes 1, 2 & 3; PH, sizes: 1, 2 & 3.

featuring GRIP-TIP technology



Screwdriver bit boxed set - 31 Piece

| | |
|-------------|---|
| Item Number | |
| T4566 | 5 |

CONTENTS: Screwdriver bit holder. Quick change chuck. 1 x screwdriver bit, slotted, sizes: 4, 5, 6, & 7mm; PZ, sizes: 1, 2 & 3; PH, sizes: 1, 2 & 3; TX, sizes: 10, 15, 20, 25, 30 & 40; Hexagon, sizes: 3, 4, 5, & 6mm. 2 x drill/driver bits, sizes: 2.5mm x PZ1 & 3.0mm x PZ2. 1 x drill/driver bit, size: 4.0mm x PZ3.



Screwdriver bit & drill set - Quick change

| | |
|-------------|---|
| Item Number | |
| T4519 | 6 |

CONTENTS: Screwdriver bit holder. 1 x screwdriver bit, slotted, sizes: 5.5 & 6.5mm; PZ, sizes: 1 & 2; PH, sizes: 1 & 2.

featuring GRIP-TIP technology



Screwdriver bit boxed set - 7 Piece

| | |
|-------------|---|
| Item Number | |
| T4583C | 5 |

- Designed for the fast removal of damaged non hardened screws
- Hexagon shaft for use with reversible drill
- Pack contains two sizes for screws 6 – 10 & 12 – 14



Damaged screw removers

| | |
|-------------|----|
| Item Number | |
| 422003 | 12 |



Damaged screw remover - Displays

| | | |
|-------------|-----------------|---|
| Item Number | | |
| T3060-CBOX | clipstrip x 6 | 1 |
| T3060-CLIP | counterbox x 12 | 1 |

SCREWDRIVER BITS - TIN COATED

featuring GRIP-TIP technology



Screwdriver bits - TiN coated - PZ

DIN ISO 1173

| Item Number | Length | Tip | Material | Quantity |
|-------------|--------|-----|-------------|----------|
| T4562TIN 1 | 25mm | PZ1 | carded pair | 5 |
| T4552TIN 1 | | | loose | 10 |
| T4562TIN 2 | 25mm | PZ2 | carded pair | 5 |
| T4552TIN 2 | | | loose | 10 |
| T4562TIN 3 | 25mm | PZ3 | carded pair | 5 |
| T4552TIN 3 | | | loose | 10 |



Screwdriver bits - TiN coated - PZ box of 15

| Item Number | Length | Tip | Quantity |
|--------------|--------|-----|----------|
| T4562TIN-215 | 25mm | PZ2 | 6 |



Screwdriver bits - TiN coated - PZ counterbox of 12

| Item Number | Length | Tip | Quantity |
|--------------|--------|-----|----------|
| T4562TIN-2CB | 25mm | PZ2 | 1 |

featuring GRIP-TIP technology



Screwdriver bits - TiN coated - PH

DIN ISO 1173

| Item Number | Length | Tip | Material | Quantity |
|-------------|--------|-----|-------------|----------|
| T4561TIN 1 | 25mm | PH1 | carded pair | 5 |
| T4551TIN 1 | | | loose | 10 |
| T4561TIN 2 | 25mm | PH2 | carded pair | 5 |
| T4551TIN 2 | | | loose | 10 |
| T4561TIN 3 | 25mm | PH3 | carded pair | 5 |
| T4551TIN 3 | | | loose | 10 |



Screwdriver bits - TiN coated - TX

DIN ISO 1173

| Item Number | Length | Tip | Material | Quantity |
|--------------|--------|------|-------------|----------|
| T4557TIN-10T | 25mm | TX10 | carded pair | 5 |
| T4557TIN 10 | | | loose | 10 |
| T4557TIN-15T | 25mm | TX15 | carded pair | 5 |
| T4557TIN 15 | | | loose | 10 |
| T4557TIN-20T | 25mm | TX20 | carded pair | 5 |
| T4557TIN 20 | | | loose | 10 |
| T4557TIN-25T | 25mm | TX25 | carded pair | 5 |
| T4557TIN 25 | | | loose | 10 |
| T4557TIN-30T | 25mm | TX30 | carded pair | 5 |
| T4557TIN 30 | | | loose | 10 |
| T4557TIN-40T | 25mm | TX40 | carded pair | 5 |
| T4557TIN 40 | | | loose | 10 |

featuring GRIP-TIP technology



Screwdriver bits - TiN coated - PZ long

DIN ISO 1173

| Item Number | Length | Tip | Material | Quantity |
|-------------|--------|-----|-------------|----------|
| T4556TIN-1T | 50mm | PZ1 | carded pair | 5 |
| T4556TIN 1 | | | loose | 10 |
| T4556TIN-2T | 50mm | PZ2 | carded pair | 5 |
| T4556TIN 2 | | | loose | 10 |

featuring GRIP-TIP technology



Screwdriver bits - TiN coated - PH long

DIN ISO 1173

| Item Number | Length | Tip | Material | Quantity |
|-------------|--------|-----|-------------|----------|
| T4555TIN 1T | 50mm | PH1 | carded pair | 5 |
| T4555TIN 2T | 50mm | PH2 | carded pair | 5 |

featuring GRIP-TIP technology



Screwdriver bits - TiN coated - PZ/slotted

| Item Number | Length | Tip | Width | Material | Quantity |
|-------------|--------|-----|-------|-------------|----------|
| T4579TIN-1T | 50mm | PZ1 | 4mm | carded pair | 5 |
| T4579TIN-2T | 50mm | PZ2 | 7mm | carded pair | 5 |

featuring GRIP-TIP technology



Screwdriver bits - TiN coated - PH/slotted

| Item Number | Length | Tip | Width | Material | Quantity |
|-------------|--------|-----|-------|-------------|----------|
| T4580TIN-1T | 50mm | PH1 | 4mm | carded pair | 5 |
| T4580TIN-2T | 50mm | PH2 | 7mm | carded pair | 5 |

CONTENTS: 1 x Screwdriver bit holder. 1 x screwdriver bit, PZ, sizes: 1 & 3. 4 x screwdriver bits, PZ, size: 2.

featuring GRIP-TIP technology



Screwdriver bits - TiN coated boxed set - 7 Piece

| Item Number | Quantity |
|-------------|----------|
| T4569TINC | 20 |

CONTENTS: 2 x screwdriver bit holders. 5 x screwdriver bits, carded pairs, PZ size: 2 x 25mm. 3 x screwdriver bits, carded pairs, PZ sizes: 1 x 25, 2 x 50 & 3 x 25mm. 1 x screwdriver bits, box of 15, PZ, size: 2.



Screwdriver bits - TiN coated - Top sellers display

| Item Number | Description | Quantity |
|---------------|-----------------|----------|
| T4562TINTSBOM | stock and stand | 1 |

SCREWDRIVER BIT HOLDERS

- Stainless steel - strong & corrosion resistant
- Magnetic base for bit retention



Screwdriver bit holder

DIN 7427

| Item Number | Length | Quantity |
|-------------|--------|----------|
| T4570 | 60mm | 10 |

- Stainless steel - strong & corrosion resistant
- Magnetic base for bit retention



Screwdriver bit holder - SDS-Plus

DIN 7427

| Item Number | Length | Quantity |
|-------------|--------|----------|
| T4564SDSC | 74mm | 10 |

- Quick locking mechanism for secure bit retention
- Free rotating collar can be held in use for extra control
- Quick release mechanism for fast & convenient bit changes



Screwdriver bit holder - Quick lock

DIN 7427

| Item Number | Length | Quantity |
|-------------|--------|----------|
| T4564EC | 51mm | 10 |

- Magnetically holds screw to bit for fast & repetitive screw driving
- Free rotating collar can be held in use for extra control

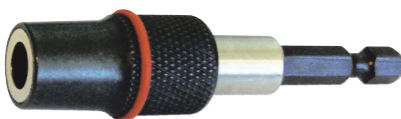

Screwdriver bit holder - Magnetic

| Item Number | Length | Quantity |
|-------------|--------|----------|
| T4565 | 60mm | 10 |

- Magnetic holder for bit retention



Screwdriver bit hand driver

| Item Number | Quantity |
|-------------|----------|
| T4581 | 6 |

- Commonly used for driving panel fixings



Nut driver - Magnetic

| Item Number | Size | Retention | Quantity |
|-------------|------|-----------|----------|
| T4598 | 8mm | loose | 10 |
| T4598C 08 | 8mm | carded | 10 |



Keyless chuck - 1/4" hex drive

| Item Number | Length | Quantity |
|-------------|--------|----------|
| T2463 | 6mm | 10 |

JIGSAW BLADES



Jigsaw blade (5 pack) - Type B

Wood, fast coarse cuts

| Item Number | Length | Thickness | Width | Material | Quantity |
|-------------|--------|-----------|----------|----------|----------|
| T0865B | 75mm | 2.5mm | 5 - 60mm | T111C | 5 |



Jigsaw blade (5 pack) - Type C

Wood, precise cuts

| Item Number | Length | Thickness | Width | Material | Quantity |
|-------------|--------|-----------|----------|----------|----------|
| T0865C | 75mm | 2.5mm | 4 - 30mm | T101B | 5 |



Jigsaw blade (5 pack) - Type L

Wood, fast clean cuts

| Item Number | Length | Thickness | Width | Material | Quantity |
|-------------|--------|-----------|----------|----------|----------|
| T0865L | 75mm | 4mm | 6 - 60mm | T101D | 5 |



Jigsaw blade (5 pack) - Type P

Wood, fast extra clean cuts

| Item Number | Length | Thickness | Width | Material | Quantity |
|-------------|--------|-----------|----------|----------|----------|
| T0865P | 95mm | 4mm | 8 - 75mm | | 5 |



Jigsaw blade (5 pack) - Type R

Wood laminates, down cut

| Item Number | Length | Thickness | Width | Material | Quantity |
|-------------|--------|-----------|----------|----------|----------|
| T0865R | 75mm | 2.5mm | 4 - 30mm | T101BR | 5 |



Jigsaw blade (5 pack) - Type T

Wood, extra clean curved cuts

| Item Number | Length | Thickness | Width | Material | Quantity |
|-------------|--------|-----------|----------|----------|----------|
| T0865T | 75mm | 2.5mm | 4 - 30mm | T244D | 5 |



Jigsaw blade (5 pack) - Type X

Wood, fast double cut

| Item Number | Length | Thickness | Width | Material | Quantity |
|-------------|--------|-----------|----------|----------|----------|
| T0865X | 75mm | 2.0mm | 3 - 60mm | | 5 |



Jigsaw blade (5 pack) - Type A

Thin metal, straight cuts

| Item Number | Length | Thickness | Width | Material | Quantity |
|-------------|--------|-----------|-----------|----------|----------|
| T0865A | 50mm | 2.5mm | 1.5 - 3mm | T118A | 5 |



Jigsaw blade (5 pack) - Type H

Thicker metal, straight cuts

| Item Number | Length | Thickness | Width | Material | Quantity |
|-------------|--------|-----------|----------|----------|----------|
| T0865H | 50mm | 1.2mm | 3 - 60mm | T118B | 5 |

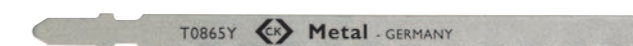

Jigsaw blade (5 pack) - Type Y

Metal & sandwich materials

| Item Number | Length | Thickness | Width | Material | Quantity |
|-------------|--------|-----------|-----------|----------|----------|
| T0865Y | 110mm | 1.2mm | 1.5 - 3mm | T318A | 5 |

- For straight cuts in soft & hardwood, wood with nails, steel, aluminium, laminate, plastics and particle board



Jigsaw blade (5 pack) - Type W

Universal

| Item Number | Length | Thickness | Width | Material | Quantity |
|-------------|--------|-------------|-----------|----------|----------|
| T0865W | 110mm | 1.8 - 2.5mm | 3 - 100mm | | 5 |

CONTENTS: 3 x jigsaw blade packs, types: A, B, C, L, R, T, W, X & Y.



Jigsaw blades - Range display

| Item Number | Description | Quantity |
|-------------|-----------------|----------|
| T0865RBOM | stock and stand | 1 |

HOSE PIPES

SCHLÄUCHE
TUYAUX SOUPLES
MANGUERAS

138

HOSE CONNECTORS

SCHLAUCHKUPPLUNGEN
RACCORDS DE FLEXIBLE
CONECTORES DE MANGUERA

139-140

HOSE ACCESSORIES

SCHLAUCHZUBEHÖR
ACCESSOIRES POUR FLEXIBLES
ACCESORIOS DE MANGUERA

140-141

WATERING SYSTEMS

WASSERSYSTEME
RÉSEAUX D'ALIMENTATION EN EAU
SISTEMAS DE AGUA

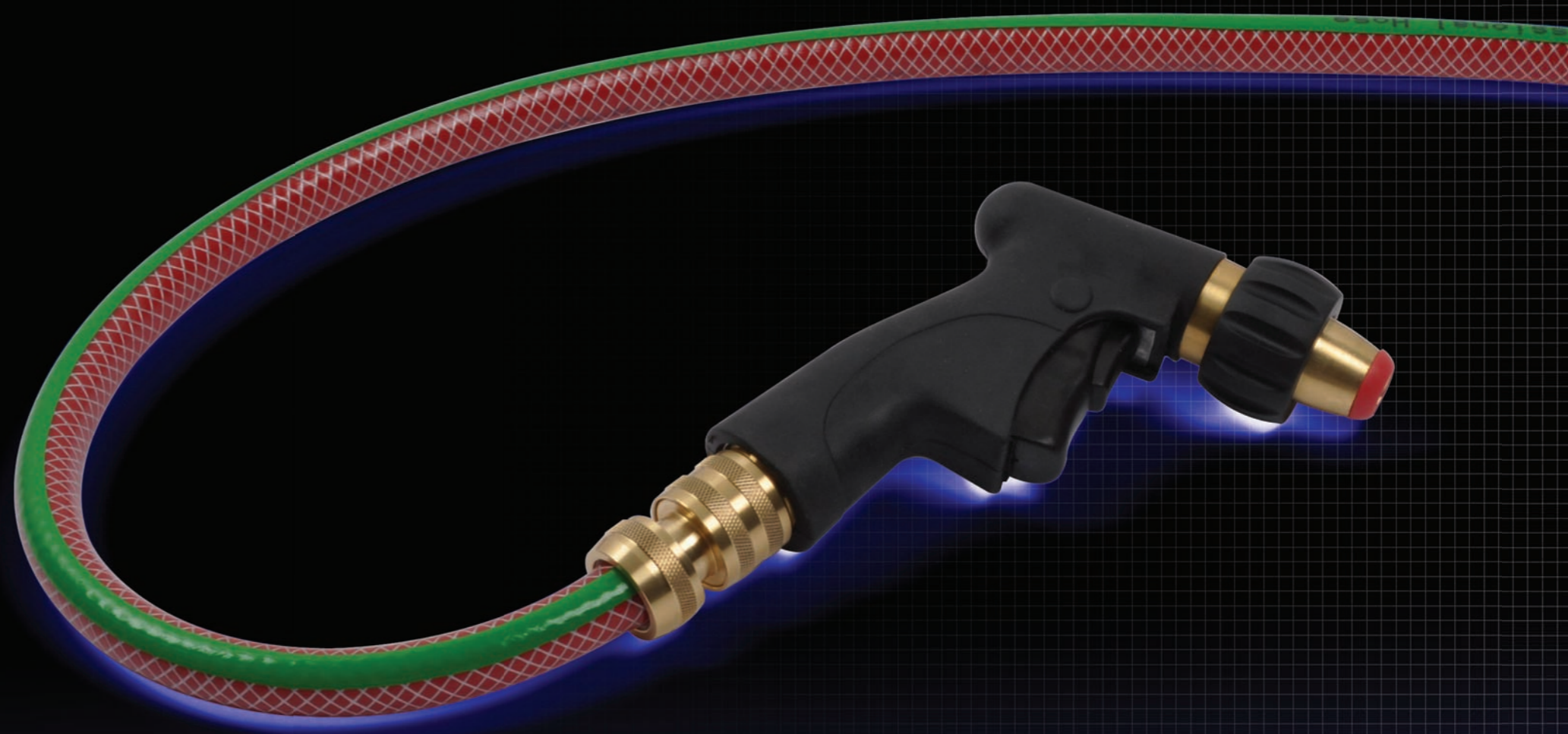



WATER SYSTEMS

The range of C.K hose connectors is precision engineered to be long lasting and leak free. The fittings are solid brass, so are much more hard wearing than plastic systems, and are rust resistant. They are compatible with all popular makes of hoses of both 1/2" and 3/4" bores.

- 1 Solid brass - tough & corrosion resistant
- 2 Ball bearing locking - secure & hardwearing
- 3 Threaded clamp for a secure fit to hosepipe

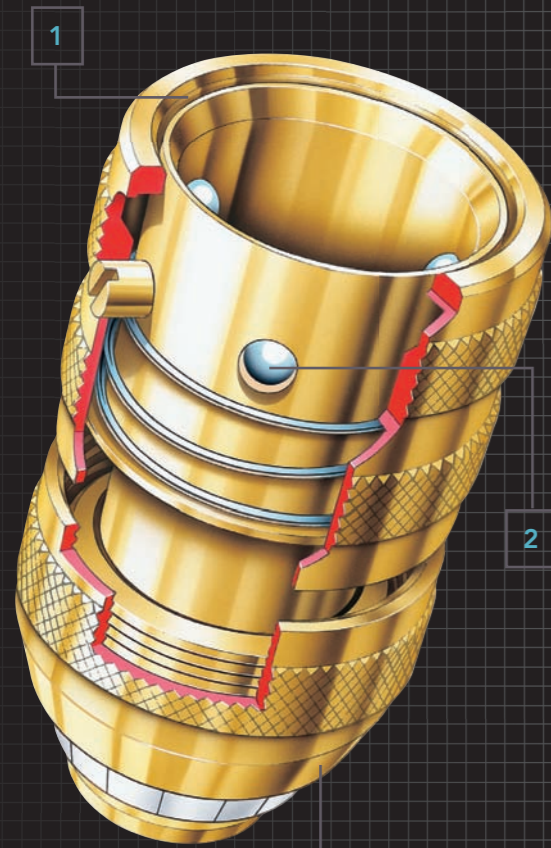

HOSE PIPES

- Premium quality, triple layered, polyester reinforced for extra strength & resistance to twisting and stretching
- Heavy duty, abrasion resistant PVC outer layer for superior elasticity at low temperatures
- UV stable
- Burst pressure 35 bar



Pro-Flex hose pipes

| Item Number | Length | Ø | Box Qty |
|-------------|--------|-----------|---------|
| G7625 15 | 15m | 13mm 1/2" | 10 |
| G7625 30 | 30m | 13mm 1/2" | 5 |
| G7625 50 | 50m | 13mm 1/2" | 3 |
| G7625 75 | 75m | 13mm 1/2" | 2 |
| G7626 15 | 15m | 19mm 3/4" | 10 |
| G7626 30 | 30m | 19mm 3/4" | 5 |
| G7626 50 | 50m | 19mm 3/4" | 3 |

- High quality, triple layered, polyester reinforced for extra strength & resistance to twisting and stretching
- Abrasion resistant PVC outer layer for long life
- UV stable
- Burst pressure 28 bar



Multi-Flex hose pipes

| Item Number | Length | Ø | Box Qty |
|-------------|--------|-----------|---------|
| G7621 15 | 15m | 13mm 1/2" | 10 |
| G7621 30 | 30m | 13mm 1/2" | 5 |
| G7621 50 | 50m | 13mm 1/2" | 3 |

HOSE CONNECTORS



Hose connector - Male

| Item Number | Ø | Box Qty |
|-------------|------|---------|
| G7904 | 1/2" | 6 |
| G7934 | 3/4" | 6 |



Hose connector - Female

| Item Number | Ø | Box Qty |
|-------------|------|---------|
| G7903 | 1/2" | 6 |
| G7933 | 3/4" | 6 |



Hose connector - Male & female

| Item Number | Ø | Box Qty |
|-------------|------|---------|
| G7905 | 1/2" | 6 |



Hose connector - Double male

| Item Number | Ø | Box Qty |
|-------------|------|---------|
| G7907 | 1/2" | 6 |



Hose connector - Triple male

| Item Number | Ø | Box Qty |
|-------------|------|---------|
| G7907Y | 1/2" | 6 |

- Automatic water cut off feature allows the interchange of accessories such as sprinklers, nozzles, spray guns, etc



Hose connector - Water stop

| Item Number | Ø | Box Qty |
|-------------|------|---------|
| G7913 | 1/2" | 6 |

- Tap connector for threaded taps

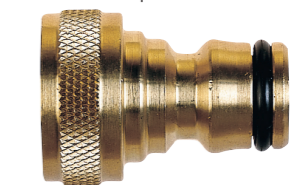

Tap connector - Threaded female

| Item Number | Ø | Box Qty |
|-------------|------|---------|
| G7915 50 | 1/2" | 6 |
| G7915 62 | 3/8" | 6 |
| G7915 75 | 3/4" | 6 |

- Ideal for converting a female threaded tap or other equipment such as jet washers to connect to a female hose coupling

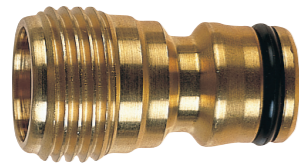

Tap connector - Threaded male

| Item Number | Ø | |
|-------------|------|---|
| G7916 50 | 1/2" | 6 |
| G7916 75 | 3/4" | 6 |

- For 3/4" external-threaded taps
- Two outlets each featuring a cut off valve that can be individually closed for convenience



Tap connector - 2 Way

| Item Number | Ø | |
|-------------|------|---|
| G7918 | 3/4" | 6 |

- Tap connector for smooth taps (Not suitable for high water pressures)

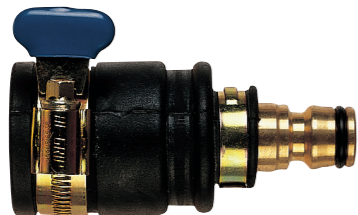

Tap connector - Push-on

| Item Number | i | |
|-------------|---------------------------|---|
| G7919 | standard bore (10 - 20mm) | 3 |
| G7928 | large bore (20 - 30mm) | 3 |

- Secure screw down hose connector for permanently joining two hoses or rejoining a hose when a damaged section has been cut out



Hose repairer

| Item Number | Ø | |
|-------------|------|---|
| G7924 | 1/2" | 6 |
| G7932 | 3/4" | 6 |

HOSE ACCESSORIES

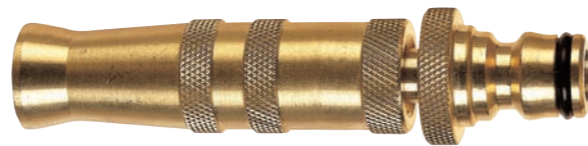

Adjustable spray nozzle

| Item Number | |
|-------------|---|
| G7912 | 6 |

- Ergonomic design for comfort
- Lockable on/off trigger for convenience



Adjustable spray gun

| Item Number | |
|-------------|---|
| G7943 | 3 |

CONTENTS: 12 x hose connectors: female (1/2"). 6 x hose connectors: male (1/2"), male & female, double male, triple male & water stop (1/2"). 6 x tap connectors: threaded female (1/2"), threaded female (5/8") & threaded female (3/4"). 3 x tap connectors: threaded male (1/2"), threaded male (3/4"), two-way (3/4"), push-on (standard bore) & push-on (large bore). 6 x hose repairers (1/2"). 6 x adjustable spray guns. 6 x adjustable spray nozzles.



Hose connector display

| Item Number | i | |
|-------------|-----------------|---|
| G7900ALS | stock and stand | 1 |

- Gentle spray pattern for damage free watering of delicate plants
- On/off volume control



Rose spray

| Item Number | 900mm 36" | |
|-------------|-----------|---|
| G7945 | | 3 |

- Covers 200m² at a 5 bar pressure
- Adjustable to 4 modes of spread: full, right, left or centre

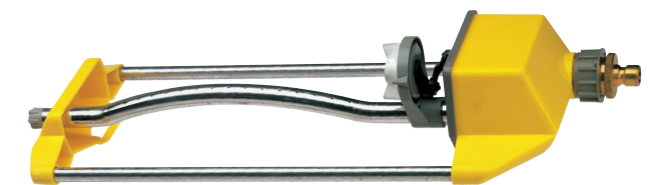

Lawn sprinkler - Oscillating

| Item Number | |
|-------------|---|
| G7756BI | 1 |

- Covers 450m² at a minimum pressure of 1.2 bar
- Adjustable watering arc for full circle or partial segment coverage

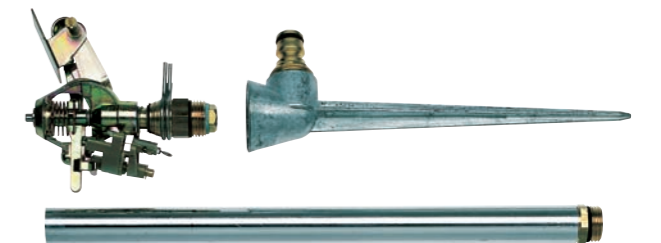

Lawn sprinkler - Pulse jet

| Item Number | |
|-------------|---|
| G7755BI | 3 |



Spare 'O' rings

| Item Number | i | |
|-------------|--------------|---|
| G7980 | packet of 20 | 6 |

SENSOPLUS ESD PLIERS & CUTTERS

SENSOPLUS ESD ZANGEN UND SCHNEIDWERKZEUGE
PINCES SENSOPLUS ESD
SENSOPLUS ESD ALICATES Y ALICATES DE CORTE

145-150**CLASSIC PLIERS & CUTTERS**

KLASSISCHE ZANGEN UND SCHNEIDWERKZEUGE
PINCES CLASSIQUES
ALICATES Y ALICATES DE CORTE CLÁSICOS

151-155**PRECISION WIRE STRIPPERS**

PRÄZISER DRAHTABISOLIERER
OUTILS À DÉNUDER DE PRÉCISION
PELACABLES DE PRÉCISION

156**CARBOFIB ESD TWEEZERS**

CARBOFIB ESD PINZETTEN
BRUCELLES CARBOFIB ESD
CARBOFIBESD PINZAS

157-158**STAINLESS STEEL TWEEZERS (NO. 4435/AISI 316)**

EDELSTAHPINZETTE (NO. 4435/AISI 316)
BRUCELLES EN ACIER INOXYDABLE (NO. 4435/AISI 316)
PINZAS DE ACERO INOXIDABLE (NO. 4435/AISI 316)

158-160**STAINLESS STEEL TWEEZERS (NO. AISI 420 4034)**

EDELSTAHPINZETTE (NO. AISI 420 4034)
BRUCELLES EN ACIER INOXYDABLE (NO. AISI 420 4034)
PINZAS DE ACERO INOXIDABLE (NO. AISI 420 4034)

160**CARBON STEEL TWEEZERS**

KOHLNSTOFFSTAHL-PINZETTEN
BRUCELLES EN ACIER AU CARBONE
PINZAS DE ACERO AL CARBONO

160-161**CERAMIC TWEEZERS**

KERAMIKPINZETTEN
BRUCELLES EN CÉRAMIQUE
PINZAS CERÁMICAS

161**INSPECTION MIRRORS**

INSPEKTIONSSPIEGEL
MIROIRS D'INSPECTION
ESPEJOS DE INSPECCIÓN

162**PLCC EXTRACTOR**

PLCC-AUSZIEHWERKZEUG
EXTRACTEUR DE BOÎTIERS PLCC
EXTRACTOR DE PLCC

162**ESD BALL PEN**

ESD-KUGELSCHREIBER
STYLO À BILLE ESD
BOLÍGRAFO ESD

162**ESD DESOLDERING TOOL**

ESD-ENTLÖTWERKZEUG
OUTIL À DESSOUDER ESD
DESOLDADOR ESD

162**TRITON ESD SCREWDRIVERS**

TRITON ESD SCHRAUBENDREHER
TOURNEVIS TRITON ESD
TRITON ESD DESTORNILLADORES

163-165**XONIC SCREWDRIVERS**

XONIC SCHRAUBENDREHER
TOURNEVIS XONIC
XONIC DESTORNILLADORES

166-168**PRECISION SCREWDRIVER SETS**

PRÄZISIONS-SCHRAUBENDREHERSÄTZE
JEUX DE TOURNEVIS DE PRÉCISION
CONJUNTOS DE DESTORNILLADORES DE PRECISIÓN

168**XONIC ESD SCREWDRIVERS**

XONIC ESD SCHRAUBENDREHER
TOURNEVIS XONIC ESD
XONIC DESTORNILLADORES

169-171**CERAMIC TRIMMERS**

KERAMIK TRIMMER
OUTILS DE RÉGLAGE EN CÉRAMIQUE
HERRAMIENTA DE CERÁMICA PARA REGULACIÓN

171**PLASTIC TRIMMERS**

KUNSTSTOFFTRIMMER
OUTILS DE RÉGLAGE EN PLASTIQUE
HERRAMIENTA DE PLÁSTICO PARA REGULACIÓN

172

ESD & PRECISION TOOLS

ESD- & PRÄZISIONSWERKZEUGE
OUTILS DE PRÉCISION & ESD
ESD Y HERRAMIENTAS DE PRECISIÓN





ESD & PRECISION TOOLS ESD- UND PRÄZISIONSWERKZEUGE OUTILS ESD ET OUTILS DE PRÉCISION HERRAMIENTAS DE PRECISIÓN Y ESD



WHAT IS ESD?

ESD stands for Electro Static Discharge.

WAS IST ESD?

ESD steht für Electro Static Discharge (elektrostatische Entladung).

QUE SIGNIFIE ESD?

ESD est l'abréviation d'Electro Static Discharge, décharge électrostatique en anglais.

¿QUÉ SIGNIFICA ESD?

ESD es la abreviación de Electro Static Discharge, es decir descarga electrostatica.

The C.K ESD & Precision range is designed specifically for electronics professionals and technicians that require products of the highest quality for ultra fine work.

Die C.K-Produktbereiche ESD und Präzisionswerkzeuge sind spezifisch für Elektroniker und Ingenieure bestimmt, die Produkte höchster Qualität für ultrafeine Arbeiten benötigen.

La gamme d'outillage ESD et d'outillage de précision de C.K est spécifiquement conçue pour les professionnels de l'électronique et les techniciens qui ont besoin de produits de la plus haute qualité pour des travaux ultra-précis.

La gama de herramientas C.K Precisión y ESD está diseñada específicamente para profesionales y técnicos de la electrónica que requieren productos de la mayor calidad para trabajos de gran precisión.

Electrostatic energy can build up rapidly on a person or object. If two electrically charged objects are brought into contact with each other, a spark may jump from one object to the other in a fast electrostatic discharge. This rapid discharge of electrostatic energy can cause damage to electronic components, particularly during the assembly and maintenance of electronic equipment. C.K ESD tools ensure that electrostatic energy is released in a controlled manner thereby preventing sparks from developing.

Elektrostatische Energie kann sich an einer Person oder einem Objekt schnell aufbauen. Sobald zwei elektrisch geladene Objekte sich berühren, kann von einem Objekt zum anderen ein Funke überspringen. Diese elektrische Entladung verursacht erhebliche Schäden an Komponenten, besonders während der Montage und Wartung. C.K-Werkzeuge gewährleisten, dass elektrostatische Energie kontrolliert abgeleitet wird und verhindert die Entwicklung von überschlagenden Funken.

L'énergie électrostatique peut s'accumuler rapidement sur une personne ou sur un objet. Si deux objets chargés électriquement sont mis en contact l'un avec l'autre, une étincelle peut jaillir d'un objet vers l'autre, constituant une décharge électrostatique rapide. Cette décharge rapide d'énergie électrostatique peut provoquer des dommages sur les composants électroniques, en particulier pendant le montage et la maintenance des matériels électroniques. Avec les outils ESD de C.K, l'énergie électrostatique est libérée de manière maîtrisée, empêchant ainsi la formation d'étincelles.

Energía electrostática puede acumularse rápidamente en una persona o en un objeto. Si entran en contacto dos objetos con carga eléctrica diferente, puede producirse una descarga electrostática rápida ocasionándose así una chispa entre los dos objetos. Esta descarga rápida de energía electrostática puede dañar componentes electrónicos, especialmente durante el montaje o el mantenimiento de aparatos electrónicos. Las herramientas ESD de C.K. garantizan una eliminación controlada de la energía electrostática, evitando así la formación de chispas.

The C.K ESD range is fully compliant with IEC 61340-5-1 ensuring safe use on sensitive equipment.

Der C.K-ESD-Produktbereich erfüllt die Norm IEC 61340-5-1 für eine sichere Anwendung an empfindlichen Komponenten.

La gamme ESD de C.K est entièrement conforme à la norme CEI 61340-5-1, ce qui garantit son utilisation sans danger sur les équipements sensibles.

La gama C.K. ESD cumple plenamente la norma IEC 61340-5-1, lo que garantiza un uso seguro en equipos sensibles.

CUTTING EDGES . DIE SCHNEIDEN . TRANCHANTS . FILO DE CORTE

The geometry of the cutting blade determines both the performance and lifetime of the product. A sharper cutting edge reduces 'cutting shock', the energy transmitted to the wire during the cutting process that can cause damage to sensitive components. There is a trade-off however, the sharper the cutting edges, the quicker the blade will wear. The cutting capacity will also be reduced.

Die Geometrie einer Schneidkante bestimmt die Leistung und die Lebensdauer des Produkts. Eine schärfere Schneidkante reduziert beim Schneidvorgang den 'Schneidschock', der auf den Draht übertragenen Energie, die empfindliche elektronische Bauteile beschädigen kann. Dies erfordert jedoch einen Kompromiss, denn je schärfer die Schneidkanten sind, desto schneller verschleißt die Schneide. Außerdem wird die Schneidleistung reduziert.

La géométrie de la lame détermine à la fois l'efficacité et la durée de vie du produit. Une arête plus tranchante réduit le « choc de coupe », c'est-à-dire l'énergie transmise au fil pendant le processus de coupe, énergie qui peut provoquer des dommages sur les composants sensibles. Il s'agit toutefois d'un compromis : plus les arêtes sont tranchantes, plus la lame s'usera rapidement. La capacité de coupe sera également réduite.

La geometría del filo de corte determina tanto el rendimiento como la vida útil del producto. Un filo de corte más afilado reduce el impacto de corte, la energía que se transmite a la alambre durante el proceso de corte que puede provocar daños en los componentes sensibles. Sin embargo, existe la desventaja, que cuanto más afilados estén los filos de corte, más rápido se desgastarán. También se verá reducida la capacidad de corte.



MINI BEVEL MIT WATE AVEC CHANFREIN MINIBISEL

Standard cut.
Highest cutting capacity.
Robust and long lasting.

Standardschnitt.
Höchste Schneidleistung.
Robust und lang anhaltend.

Coupe standard.
Capacité de coupe la plus élevée.
Robustesse et longévité.

Corte estándar.
La mayor capacidad de corte.
Robusta y duradera.



FULL FLUSH MIT KLEINER WATE AVEC MICRO-CHANFREIN CORTE A RAS COMPLETO

Almost full flush cutting.
Reduced cutting shock.

Nahezu bündiger Schnitt.
Reduzierter Schneidschock.

Coupe presque complètement à ras.
Choc de coupe réduit.

Corte casi completamente a ras.
Impacto de corte reducido.



EXTRA FULL FLUSH OHNE WATE COUPE À RAS CORTE A RAS COMPLETO EXTRA

Perfectly flush cutting.
Suitable for non-shock cutting.

Perfekter bündiger Schnitt.
Geeignet für Schneiden ohne
Schneidschock.

Coupe parfaitement à ras.
Convient pour les coupes sans chocs.

Corte a ras perfecto.
Adecuado para cortes libres de impacto.



SENSOPLUS ESD

DISSIPATIVE PRECISION PLIERS & CUTTERS

PREMIUM-QUALITÄT - ZANGEN UND SCHNEIDWERKZEUGE
 PINCES DISSIPATIVES DE PRÉCISION
 HERRAMIENTAS DE CORTE Y ALICATES DE PRECISIÓN ANTIESTÁTICOS



1 Special alloy steel, drop forged, hardened & tempered for exceptional strength & durability

Legierter Spezialstahl, gesenkgeschmiedet, gehärtet und angelassen für außerordentliche Festigkeit und Dauerhaftigkeit
 Acier alliée spécial, matricé, trempé pour une résistance et une durabilité exceptionnelles
 Acero de aleación especial, forjado, endurecido y templado para una resistencia y durabilidad excepcionales

2 Precision box joint construction for permanent, adjustment free jaw alignment

Präzises durchgestecktes Gewerbe für permanente, einstellungsfreie Backenausrichtung
 Construction à charnière entrecassée de précision pour un alignement permanent des mâchoires, ne nécessitant aucun réglage
 Construcción de la junta de precisión en caja para un alineamiento de las mordazas permanente y sin necesidad de ajustes

3 Induction hardened jaws for outstanding long term performance

Induktionsgehärtete Schneiden für lange Lebensdauer
 Mâchoires trempées par induction pour une efficacité remarquable sur la durée
 Mordazas templadas por inducción para un excelente rendimiento duradero

4 Mirror polished surface eliminates the risk of damage from flaking chrome

Spiegelpolierte Oberflächen als Sicherheit gegen abblätternde Chrompartikel
 La surface brillante élimine le risque de dommages dus à l'écaillage du chrome
 Superficie pulida que elimina el riesgo de daños por cromo descascarillado

5 Spot welded double leaf springs for consistent, repetitive action

Unverlierbare punktgeschweißte doppelte Blattfedern garantieren optimale Funktion über die gesamte Lebensdauer
 Ressorts à double lame soudés par points pour une action répétitive constante
 Muelles de doble hoja soldadas por puntos para obtener una acción homogénea y repetitiva

6 Ergonomically designed dual component handles for increased comfort & control

Ergonomisch gestalteter Zwei-Komponenten Griff, rutschhemmend für erhöhten Komfort und bessere Handhabung
 Branches bicomposant de conception ergonomique pour un confort accru et une meilleure maîtrise de l'outil
 Mangos de dos componentes y diseño ergonómico para mayor comodidad y control

7 Fully ESD compliant for safe use on sensitive electronic components

Vollständig ESD-konform, ableitfähig in allen Bereichen
 Entièrement conformes ESD pour une utilisation en toute sécurité sur les composants électroniques sensibles
 Cumple por completo la normativa eléctrica para ESD, para uso seguro con componentes electrónicos sensibles

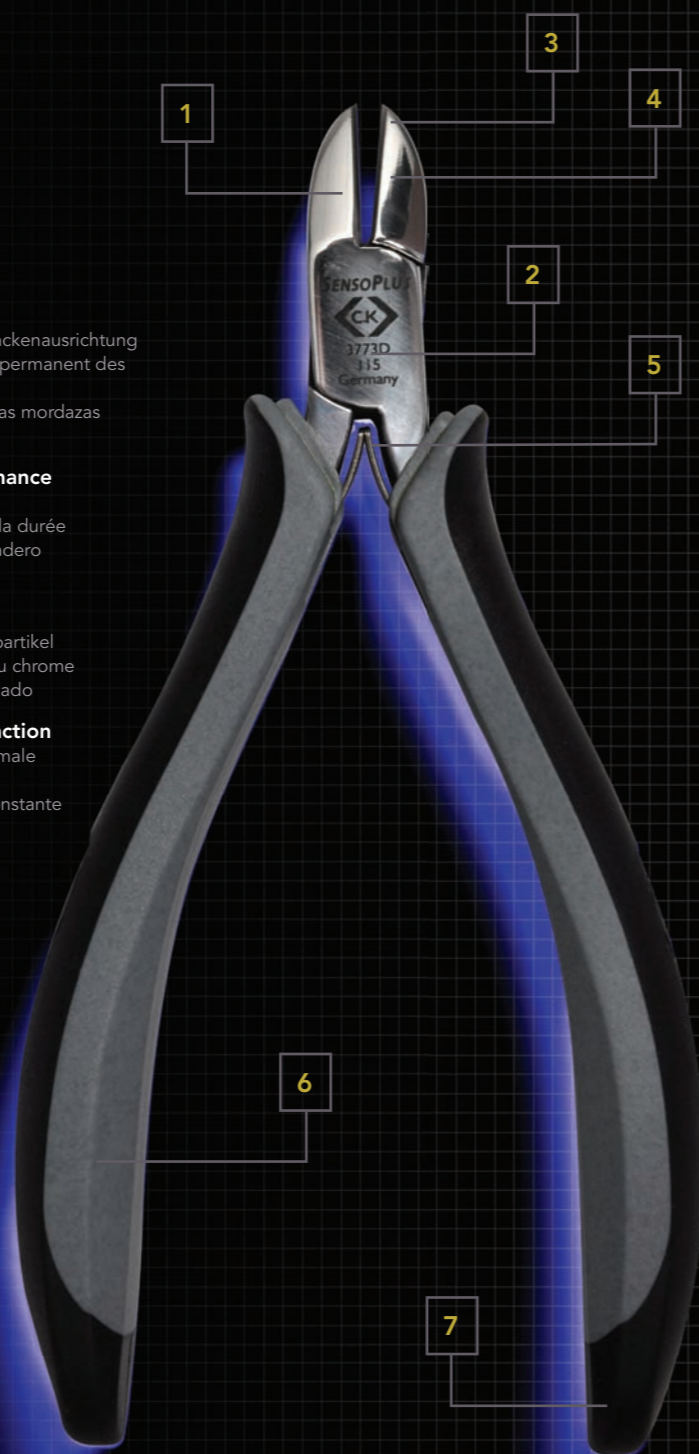

SENSOPLUS ESD PLIERS & CUTTERS

- Tungsten carbide blades for outstanding cutting life



Side cutters 3779D

BS EN 61340 2

| Item Number | Ø | ● | ○ | WC | 📦 |
|-------------|----------|----------|----------|----|---|
| T3779D 115 | 2.0 / 12 | 1.0 / 18 | 0.6 / 22 | 🚫 | 1 |



- Tungsten carbide blades for outstanding cutting life



Side cutters 3787D

BS EN 61340 2

| Item Number | Ø | ● | ○ | WC | 📦 |
|-------------|----------|----------|----------|----|---|
| T3787DF 115 | 1.8 / 13 | 0.8 / 20 | 0.4 / 26 | 🚫 | 1 |



- Tungsten carbide blades for outstanding cutting life



Oblique cutters 3760D

BS EN 61340 2

| Item Number | Ø | ● | ○ | WC | 📦 |
|-------------|----------|----------|----------|----|---|
| T3760DF 110 | 2.0 / 12 | 1.0 / 18 | 0.6 / 22 | 🚫 | 1 |

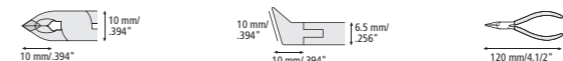

Side cutters 3773D

BS EN 61340 2

| Item Number | Ø | ● | ○ | i | 📦 |
|--------------|----------|----------|----------|---|---|
| T3773D 115 | 1.5 / 15 | 1.0 / 18 | 0.4 / 26 | 🚫 | 1 |
| T3773DF 115 | 1.5 / 15 | 1.0 / 18 | - | 🚫 | 1 |
| T3773DEF 115 | 1.5 / 15 | 0.8 / 20 | - | 🚫 | 1 |



Side cutters 3880D

BS EN 61340 2

| Item Number | Ø | ● | ○ | i | 📦 |
|-------------|----------|----------|----------|---|---|
| T3880DF 110 | 1.5 / 15 | 0.8 / 20 | 0.4 / 26 | 🚫 | 1 |

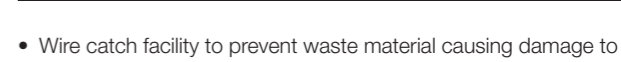

- Wire catch facility to prevent waste material causing damage to sensitive equipment



Side cutters 3782D

BS EN 61340 2

| Item Number | Ø | ● | ○ | i | 📦 |
|--------------|----------|----------|----------|---|---|
| T3782D 115 | 1.5 / 15 | 1.0 / 18 | 0.4 / 26 | 🚫 | 1 |
| T3782DEF 115 | 1.5 / 15 | 0.8 / 20 | - | 🚫 | 1 |





Side cutters 3781D

BS EN 61340 2



| Item Number | | | | | |
|--------------|----------|----------|----------|--|---|
| T3781D 115 | 1.5 / 15 | 1.0 / 18 | 0.3 / 28 | | 1 |
| T3781DF 115 | 1.5 / 15 | 1.0 / 18 | - | | 1 |
| T3781DEF 115 | 1.5 / 15 | 0.8 / 20 | - | | 1 |

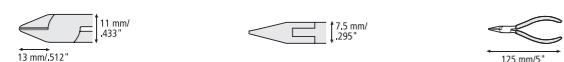

Oblique cutters 3799D

BS EN 61340 2



| Item Number | | | | | |
|--------------|----------|----------|----------|--|---|
| T3799DF 110 | 1.2 / 16 | 1.0 / 18 | 0.4 / 26 | | 1 |
| T3799DEF 110 | 1.0 / 18 | 0.8 / 20 | - | | 1 |

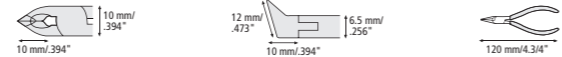

Snipe nose pliers 3772D

BS EN 61340 2



| Item Number | | | |
|--------------|--|--|---|
| T3772D 120 | | | 1 |
| T3772 1D 120 | | | 1 |



Snipe nose pliers 3769D

BS EN 61340 2



| Item Number | | | |
|-------------|--|--|---|
| T3769D 150 | | | 1 |

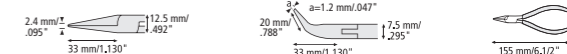

Side cutters 3780D

BS EN 61340 2



| Item Number | | | | | |
|-------------|----------|----------|---|--|---|
| T3780DF 110 | 1.5 / 15 | 0.8 / 20 | - | | 1 |

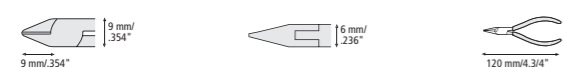

Oblique cutters 3786D

BS EN 61340 2



| Item Number | | | | | |
|-------------|----------|----------|---|--|---|
| T3786DF 120 | 0.8 / 20 | 0.6 / 22 | - | | 1 |

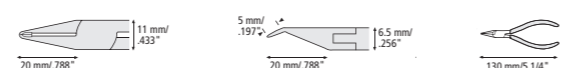

Snipe nose pliers 3777D

BS EN 61340 2



| Item Number | | | |
|-------------|--|--|---|
| T3777D 150 | | | 1 |

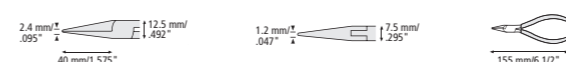

Flat nose pliers 3770D

BS EN 61340 2



| Item Number | | | |
|--------------|--|--|---|
| T3770 1D 120 | | | 1 |
| T3770D 120 | | | 1 |

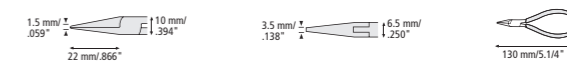

Side cutters 3766D

BS EN 61340 2



| Item Number | | | | | |
|--------------|----------|----------|---|--|---|
| T3766DF 110 | 1.5 / 15 | 0.8 / 20 | - | | 1 |
| T3766DEF 110 | 1.5 / 15 | 0.6 / 22 | - | | 1 |

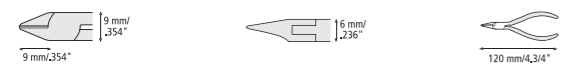

Oblique cutters 3871D

BS EN 61340 2



| Item Number | | | | | |
|-------------|----------|----------|---|--|---|
| T3871DF 120 | 0.8 / 20 | 0.6 / 22 | - | | 1 |

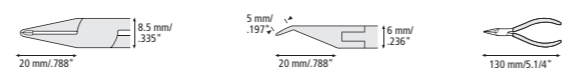

Snipe nose pliers 3767D

BS EN 61340 2



| Item Number | | | |
|-------------|--|--|---|
| T3767D 120 | | | 1 |

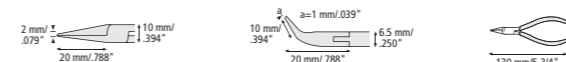

Needle nose pliers 3783D

BS EN 61340 2



| Item Number | | | |
|-------------|--|--|---|
| T3783D | | | 1 |

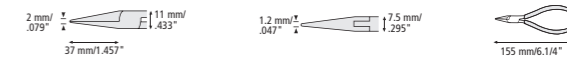



Round nose pliers 3771D

BS EN 61340 2

| Item Number | i | 1 |
|-------------|---|---|
| T3771D 120 | | 1 |
| | | |

CONTENTS: Side cutter T3773D. Snipe nose plier T3772D. Positioning tweezer T2334. Precision tweezer T2343. 1 x screwdriver, slotted, sizes: 1.5 x 60, 1.8 x 60, 2.5 x 60, 2.5 x 75, 3.0 x 100 & 4.0 x 100mm; PH, sizes: 000 x 60, 00 x 60, 0 x 60 & 1 x 80mm.



ESD tool kit - 14 Piece

BS EN 61340 2

| Item Number | 1 |
|-------------|---|
| T3707DX | 1 |

CONTENTS: Side cutter T3773D. Side cutter T3880DF. Side cutter T3766DF. Oblique cutter T3786DF. Snipe nose plier T3772D. Flat nose plier T3770D.



Pliers set - 6 Piece

BS EN 61340 2

| Item Number | 1 |
|-------------|---|
| T3703D | 1 |



CLASSIC PRECISION PLIERS & CUTTERS

PREMIUM-QUALITÄT - ZANGEN UND SCHNEIDWERKZEUGE
PINCES DE PRÉCISION
HERRAMIENTAS DE CORTE Y ALICATES DE PRECISIÓN

1 Special alloy steel, drop forged, hardened & tempered for exceptional strength & durability

Legierter Spezialstahl, gesenkgeschmiedet, gehärtet und angelassen für außerordentliche Festigkeit und Dauerhaftigkeit
Acier allié spécial, matricé, trempé pour une résistance et une durabilité exceptionnelles
Acero de aleación especial, forjado, endurecido y templado para una resistencia y durabilidad excepcionales

2 Precision box joint construction for permanent, adjustment free jaw alignment

Präzises durchgestecktes Gewerbe für permanente, einstellungsfreie Backenausrichtung
Construction à charnière entrepassée de précision pour un alignement permanent des mâchoires, ne nécessitant aucun réglage
Construcción de la junta de precisión en caja para un alineamiento de las mordazas permanente y sin necesidad de ajustes

3 Induction hardened jaws for outstanding long term performance

Induktionsgehärtete Schneiden für lange Lebensdauer
Mâchoires trempées par induction pour une efficacité remarquable sur la durée
Mordazas endurecidas por inducción para un rendimiento duradero y duradero

4 Mirror polished surface eliminates the risk of damage from flaking chrome

Spiegelpolierte Oberflächen als Sicherheit gegen abblätternde Chrompartikel
La surface brillantée élimine le risque de dommages dus à l'écaillage du chrome
Superficie esmerilada que elimina el riesgo de daños por descamación del cromo

5 Spot welded double leaf springs for consistent, repetitive action

Unverlierbare, punktgeschweißte, doppelte Blattfedern garantieren optimale Funktion über die gesamte Lebensdauer
Ressorts à double lame soudés par points pour une action répétitive constante
Muelles de doble hoja de soldadura por puntos para obtener una acción homogénea y repetitiva

6 PVC handles for comfort & grip

PVC-Griffe für Komfort und Griffigkeit
Branches PVC pour le confort et la tenue en main
Mangos de PVC para comodidad y agarre



CLASSIC™

CLASSIC PLIERS & CUTTERS

- Tungsten carbide blades for outstanding cutting life



Side cutters 3779

| Item Number | Ø | Ø | Ø | WC | 📦 |
|-------------|----------|----------|----------|----|---|
| T3779 | 2.0 / 12 | 1.0 / 18 | 0.6 / 22 | 🔴 | 1 |



Side cutters 3775

| Item Number | Ø | Ø | Ø | i | 📦 |
|-------------|----------|----------|----------|---|---|
| T3775 | 2.0 / 12 | 1.5 / 15 | 0.7 / 21 | 🔴 | 1 |
| T3775EF | 2.0 / 12 | 1.3 / 18 | - | 🟢 | 1 |



Side cutters 3773

| Item Number | Ø | Ø | Ø | i | 📦 |
|-------------|----------|----------|----------|---|---|
| T3773 | 1.5 / 15 | 1.0 / 18 | 0.4 / 26 | 🔴 | 1 |
| T3773F | 1.5 / 15 | 1.0 / 18 | - | 🔵 | 1 |
| T3773EF | 1.5 / 15 | 0.8 / 20 | - | 🟢 | 1 |



Side cutters 3880

| Item Number | Ø | Ø | Ø | i | 📦 |
|-------------|----------|----------|---|---|---|
| T3880F | 1.5 / 15 | 0.8 / 20 | - | 🔵 | 1 |



Side cutters 3781

| Item Number | Ø | Ø | Ø | i | 📦 |
|-------------|----------|----------|----------|---|---|
| T3781 | 1.5 / 15 | 1.0 / 18 | 0.3 / 28 | 🔴 | 1 |



Side cutters 3780

| Item Number | Ø | Ø | Ø | i | 📦 |
|-------------|----------|----------|---|---|---|
| T3780F | 1.5 / 15 | 0.8 / 20 | - | 🔵 | 1 |
| T3780EF | 1.5 / 15 | 0.6 / 22 | - | 🟢 | 1 |

- Laid-on joint



Side cutters 3774

| Item Number | Ø | Ø | Ø | i | 📦 |
|-------------|----------|----------|----------|---|---|
| T3774 | 1.5 / 15 | 1.0 / 18 | 0.4 / 26 | 🔴 | 1 |



Oblique cutters 3778

| Item Number | Ø | Ø | Ø | i | 📦 |
|-------------|----------|----------|----------|---|---|
| T3778F | 1.6 / 14 | 1.2 / 16 | 0.5 / 24 | 🔵 | 1 |



Oblique cutters 3799

| Item Number | Ø | Ø | Ø | i | 📦 |
|-------------|----------|----------|----------|---|---|
| T3799F | 1.2 / 16 | 1.0 / 18 | 0.4 / 26 | 🔵 | 1 |



Top cutters 3776

| Item Number | Ø | Ø | Ø | i | 📦 |
|-------------|----------|----------|----------|---|---|
| T3776F | 1.6 / 14 | 1.2 / 16 | 0.5 / 24 | 🔵 | 1 |

| Item Number | Ø | Ø | Ø | i | 📦 |
|-------------|----------|----------|---|---|---|
| T3776EF 5 | 2.0 / 12 | 1.6 / 14 | - | 🟢 | 1 |



Oblique cutters 3786

| Item Number | Ø | Ø | Ø | i | 📦 |
|-------------|----------|----------|---|---|---|
| T3786F 4 | 0.8 / 20 | 0.6 / 22 | - | 🔵 | 1 |



Snipe nose pliers 3772

| Item Number | i | 📦 |
|-------------|---|---|
| T3772 | 🟡 | 1 |
| T3772 1 | 🟡 | 1 |



Snipe nose pliers 3777

| Item Number | i | |
|-------------|---|---|
| T3777 | | 1 |
| | | |



Snipe nose pliers 3767

| Item Number | i | |
|-------------|---|---|
| T3767 | | 1 |
| | | |



Snipe nose pliers 3769

| Item Number | i | |
|-------------|---|---|
| T3769 | | 1 |
| | | |



Flat nose pliers 3770

| Item Number | i | |
|-------------|---|---|
| T3770 | | 1 |
| | | |



Flat nose pliers 3789

| Item Number | i | |
|-------------|---|---|
| T3789 | | 1 |
| | | |



Needle nose pliers 3783

| Item Number | i | |
|-------------|---|---|
| T3783 | | 1 |
| | | |



Round nose pliers 3771

| Item Number | i | |
|-------------|---|---|
| T3771 | | 1 |
| | | |

- Laid-on joint



Wire stripping pliers 3796

| Item Number | Ø | |
|-------------|-------------|---|
| T3796 5 | 0.1 - 0.8mm | 1 |
| | | |

CONTENTS: Side cutter T3773. Side cutter T3780F. Oblique cutter T3799F. Snipe nose plier T3772. Snipe nose plier T3767. Flat nose plier T3770.



Pliers set - 6 Piece

| Item Number | |
|-------------|---|
| T3703 | 1 |



PRECISION WIRE STRIPPERS

- Compact precision wire strippers for repeatable, damage free stripping of PVC, Teflon & similar coated wire
- Graduated depth stop for stripping to precise lengths
- Specially hardened blades for outstanding long term performance

- Fully ESD compliant for safe use on sensitive electronic components
- Adjustable to strip 6 wire diameters



Wire stripper 3757ESD

BS EN 61340 2

| Item Number | Ø | |
|-------------|--------------------------------------|---|
| T3757ESD 2 | 0.25, 0.30, 0.40, 0.50, 0.60, 0.80mm | 1 |

- For fibre optic cable



Wire stripper 3755

| Item Number | Ø | |
|-------------|--------|---|
| T3755 018 | 0.18mm | 1 |



Wire stripper 3756

| Item Number | Ø | |
|-------------|--------|---|
| T3756 20 | 0.20mm | 1 |
| T3756 25 | 0.25mm | 1 |
| T3756 30 | 0.30mm | 1 |
| T3756 40 | 0.40mm | 1 |
| T3756 50 | 0.50mm | 1 |
| T3756 60 | 0.60mm | 1 |
| T3756 80 | 0.80mm | 1 |
| T3756 100 | 1.00mm | 1 |

- Adjustable to strip 6 wire diameters



Wire stripper 3757

| Item Number | Ø | |
|-------------|---------------|---|
| 330009 | 0.12 - 0.40mm | 1 |
| 330013 | 0.25 - 0.80mm | 1 |
| 330011 | 0.30 - 1.00mm | 1 |

- Adjustable to strip 6 wire diameters



Wire stripper 3759

| Item Number | Ø | |
|-------------|--------------------------------------|---|
| 330012 | 0.25, 0.30, 0.40, 0.50, 0.60, 0.80mm | 1 |

CARBOFIB ESD DISSIPATIVE TWEEZERS

ABLEITFÄHIGE PINZETTEN
BRUCELLES DISSIPATIVES
PINZAS ANTIESTÁTICAS



1 Carbon fibre tips allow for safe handling of highly sensitive electrical components

Carbonfiberspitzen ermöglichen die sichere Handhabung von hochempfindlichen, elektrischen Komponenten
Pointes en fibre de carbone pour la manipulation en toute sécurité des composants électriques hautement sensibles
Puntas de fibra de carbono que permiten una manipulación segura de componentes muy sensibles

2 High grade, stainless steel bow – acid & corrosion resistant

Hochwertiger Edelstahlbügel - säure- und korrosionsresistent
Branches en acier inoxydable- résistantes aux acides et à la corrosion
Arco de acero inoxidable de alta calidad, resistente a la corrosión y al ácido

3 Precision welded joint for consistent, repetitive action

Präzise verschweißte Verbindungsstelle für stabile Handhabung und lange Lebensdauer
Assemblage par soudage de précision pour une action répétitive constante
Articulación soldada de precisión para que accione de manera coherente y repetitiva

4 Fully ESD compliant for safe use on sensitive electronic components

Vollständig ESD-konform, ableitfähig in allen Bereichen
Entièrement conformes ESD pour une utilisation en toute sécurité sur les composants électroniques sensibles
Cumple por completo la normativa eléctrica para ESD, para uso seguro con componentes electrónicos sensibles

5 Anti-magnetic to prevent electro-magnetic damage

Anti-magnetisch
Antimagnétiques pour prévenir les dégâts électromagnétiques
Amagnéticas para evitar los daños electromagnéticos

6 Heat resistant up to 270°C for safe use

Hitze resistent bis zu 270°C
Réfractaires à la chaleur jusqu'à 270°C pour une utilisation en toute sécurité
Resistente al calor, hasta los 270°C para un uso seguro



CARBOFIB ESD TWEEZERS

- Fine tips



Tweezers - Positioning 2390

BS EN 61340 2



| Item Number | Length | Type | Material | Quantity |
|-------------|--------|------|----------|----------|
| T2390 | 130mm | CF | 259CF | 1 |

- Fine, extra slim tips



Tweezers - Positioning 2391

BS EN 61340 2



| Item Number | Length | Type | Material | Quantity |
|-------------|--------|------|----------|----------|
| T2391 | 130mm | CF | 5CF | 1 |

- Rounded tips, 2mm wide



Tweezers - Positioning 2392

BS EN 61340 2



| Item Number | Length | Type | Material | Quantity |
|-------------|--------|------|----------|----------|
| T2392 | 130mm | CF | 249CF | 1 |

STAINLESS STEEL TWEEZERS (NO. 4435/AISI 316)

- High grade, stainless steel bow – acid & corrosion resistant
- Precision welded joint for consistent, repetitive action
- Anti-magnetic to prevent electro-magnetic damage

- Superfine tips, angled at 60°



Tweezers - Precision 2330

| Item Number | Length | Type | Material | Quantity |
|-------------|--------|------|----------|----------|
| T2330 | 110mm | SA | 5B.SA | 1 |

- Superfine tips, offset & angled at 60°



Tweezers - Precision 2331

| Item Number | Length | Type | Material | Quantity |
|-------------|--------|------|----------|----------|
| T2331 | 115mm | SA | 5C.SA | 1 |

- Superfine tips, straight



Tweezers - Precision 2341

| Item Number | Length | Type | Material | Quantity |
|-------------|--------|------|----------|----------|
| T2341 | 110mm | SA | 5B.SA | 1 |

- Fine, sharp tips, straight



Tweezers - Precision 2340

| Item Number | Length | Type | Material | Quantity |
|-------------|--------|------|----------|----------|
| T2340 | 110mm | SA | 3C.SA | 1 |

- Fine tips, straight



Tweezers - Precision 2343

| Item Number | Length | Type | Material | Quantity |
|-------------|--------|------|----------|----------|
| T2343 | 130mm | SA | MM.SA | 1 |

- Fine tips, curved



Tweezers - Precision 2339

| Item Number | Length | Type | Material | Quantity |
|-------------|--------|------|----------|----------|
| T2339 | 110mm | SA | 7.SA | 1 |

- Flat, blunt tips, finely serrated inside



Tweezers - Precision 2381

| Item Number | Length | Type | Material | Quantity |
|-------------|--------|------|----------|----------|
| T2381 | 120mm | SA | 00D.SA | 1 |

- Fine, bent tips, fine cross-cut inside



Tweezers - Positioning 2359

| Item Number | Length | Type | Material | Quantity |
|-------------|--------|------|----------|----------|
| T2359 | 150mm | SA | 22.SA | 1 |

- Flat, round tips, straight



Tweezers - Positioning 2360

| Item Number | Length | Type | Material | Quantity |
|-------------|--------|------|----------|----------|
| T2360 | 120mm | SA | 2A.SA | 1 |

- Spatula square flat tips



Tweezers - Flat tip 2364

| Item Number | Length | Type | Material | Quantity |
|-------------|--------|------|----------|----------|
| T2364 | 105mm | SA | 127.SA | 1 |

- Reverse action
- For SOT-packages, monolithic chip capacitors, etc



Tweezers - Cross pattern 2349

| Item Number | Length | Type | Material | Quantity |
|-------------|--------|------|----------|----------|
| T2349 | 120mm | SA | X104.SA | 1 |

- Cross gripping pattern
- For SOT-packages, monolithic chip capacitors, etc



Tweezers - Positioning 2334

| Item Number | Length | Type | Material | Quantity |
|-------------|--------|------|----------|----------|
| T2334 | 120mm | SA | SM104.SA | 1 |

- Grooved tips angled at 30°
- For cylindrical devices up to 1mm Ø



Tweezers - Positioning 2336

| Item Number | Length | Type | Material | Quantity |
|-------------|--------|------|----------|----------|
| T2336 | 120mm | SA | SM115.SA | 1 |

- Tips round inside
- For cylindrical devices up to 1mm Ø



Tweezers - Positioning 2351

| Item Number | Length | Type | Material | Quantity |
|-------------|--------|------|----------|----------|
| T2351 | 115mm | SA | 582.SA | 1 |

- Tips round inside
- For cylindrical devices up to 2mm Ø



Tweezers - Positioning 2354

| Item Number | Length | Type | Material | Quantity |
|-------------|--------|------|----------|----------|
| T2354 | 115mm | SA | 578.SA | 1 |

- Fine, straight tips



Tweezers - Positioning 2316

| Item Number | Length | Type | Material | Quantity |
|-------------|--------|------------|----------|----------|
| T2316 | 105mm | SA (18/10) | | 1 |

- Fine, bent tips



Tweezers - Positioning 2317

| Item Number | Length | Material | Quantity |
|-------------|--------|------------|----------|
| T2317 | 105mm | SA (18/10) | 1 |

- Fine, straight extra long tips



Tweezers - Positioning 2318

| Item Number | Length | Material | Quantity |
|-------------|--------|------------|----------|
| T2318 | 130mm | SA (18/10) | 1 |

STAINLESS STEEL TWEEZER (NO. 4034/AISI 420)

- High grade, stainless steel bow – acid & corrosion resistant
- Precision welded joint for consistent, repetitive action

- Fine, straight extra long tips



Tweezers - Precision 2319

| Item Number | Length | Material | Quantity |
|-------------|--------|----------|----------|
| T2319 | 120mm | S | 1 |

CARBON STEEL TWEEZERS

- Hardened, carbon steel bow for long term performance
- Precision welded joint for consistent, repetitive action

- Fine, blunt tips, 2mm wide, finely serrated inside



Tweezers - Universal 2301

| Item Number | Length | Material | Quantity |
|-------------|--------|----------|----------|
| T2301 | 115mm | C | 1 |

- Fine, blunt tips, 2mm wide, finely serrated inside
- Matt black anti-glare finish



Tweezers - Universal 2302

| Item Number | Length | Material | Quantity |
|-------------|--------|----------|----------|
| T2302 | 115mm | C | 1 |

- Blunt tips, 3.5mm wide, finely serrated inside



Tweezers - Universal 2307

| Item Number | Length | Material | Quantity |
|-------------|--------|----------|----------|
| T2307 | 145mm | C | 1 |

- Blunt tips, 3.5mm wide, finely serrated inside
- Matt black anti-glare finish



Tweezers - Universal 2308

| Item Number | Length | Material | Quantity |
|-------------|--------|----------|----------|
| T2308 | 145mm | C | 1 |

- Blunt tips, 3.5mm wide, finely serrated inside
- PVC coated



Tweezers - Universal 2308A

| Item Number | Length | Material | Quantity |
|-------------|--------|----------|----------|
| T2308A | 145mm | C | 1 |

- Blunt tips, 2mm wide, fine cross cut inside



Tweezers - Universal 2309

| Item Number | Length | Material | Quantity |
|-------------|--------|----------|----------|
| T2309 | 140mm | C | 1 |

- Fine, blunt tips, bent, finely serrated inside
- With guide pin



Tweezers - Universal 2314

| Item Number | Length | Material | Quantity |
|-------------|--------|----------|----------|
| T2314 | 150mm | C | 1 |

- Fine, blunt tips, bent, finely serrated inside
- With guide pin
- Matt black anti-glare finish



Tweezers - Universal 2315

| Item Number | Length | Material | Quantity |
|-------------|--------|----------|----------|
| T2315 | 150mm | C | 1 |

- Fine, blunt tips, 2mm wide, straight
- Finely serrated inside



Tweezers - Radio 2327

| Item Number | Length | Material | Quantity |
|-------------|--------|----------|----------|
| T2327 | 155mm | C | 1 |

- Fine, blunt tips, 2mm wide, bent
- Finely serrated inside



Tweezers - Radio 2328

| Item Number | Length | Material | Quantity |
|-------------|--------|----------|----------|
| T2328 | 155mm | C | 1 |

- Reverse action. Soldering tweezers with finger pads to protect against heat
- Fine, bent tips, 2.5mm wide



Tweezers - Cross pattern 2313A

| Item Number | Length | Material | Quantity |
|-------------|--------|----------|----------|
| T2313A | 160mm | C | 1 |

CERAMIC TWEEZERS

- Zirconia ceramic tips - safe handling of highly sensitive electrical components, highly acid resistant (other than Hydrofluoric), solder repellent & electrically non-conductive
- Heat resistant up to 1000°C for safe use
- Aluminium bow – lightweight construction
- Precision welded joint for consistent, repetitive action
- Non-magnetic to prevent electro-magnetic damage

- Fine, straight tips



Tweezers - Ceramic 2345A

| Item Number | Length | Material | TYPE | Quantity |
|-------------|--------|----------|----------|----------|
| T2345A | 140mm | CER | 73 MZ AL | 1 |

INSPECTION MIRRORS



Inspection mirror - Fixed

| Item Number | Length | Ø | Weight |
|-------------|--------|------|--------|
| T5911 20 | 164mm | 20mm | 6 |



Inspection mirror - Telescopic

| Item Number | Length | Ø | Weight |
|-------------|-------------|------|--------|
| T5912 38 | 125 - 685mm | 38mm | 6 |
| T5912 55 | 125 - 560mm | 55mm | 6 |



Inspection mirror - Telescopic, long

| Item Number | Length | Ø | Weight |
|-------------|-------------|------|--------|
| T5913 32 | 180 - 520mm | 32mm | 6 |



Inspection mirror - Telescopic, extra long

| Item Number | Length | Ø | Weight |
|-------------|-------------|------|--------|
| T5914 55 | 250 - 780mm | 55mm | 6 |

PLCC EXTRACTOR

- For PLCC-components (20-124 pins)
- Self opening for repetitive action
- Fully ESD compliant for safe use on sensitive electronic components



PLCC Extractor

BS EN 61340 2

| Item Number | Length | Weight |
|-------------|----------|--------|
| T2371 | 100mm 4" | 6 |

ESD BALL PEN



ESD ball pen

BS EN 61340 2

| Item Number | Weight |
|-------------|--------|
| Z1123 | 1 |

ESD DESOLDERING TOOL



ESD desoldering tool

BS EN 61340 2

| Item Number | Length | Weight | Description | Quantity |
|-------------|--------------|--------|------------------|----------|
| T6103A | 210mm 8 1/4" | | desoldering tool | 1 |
| T6104A | - | | spare nozzle | 1 |

TRITON ESD

DISSIPATIVE SCREWDRIVERS

ABLEITFÄHIGE SCHRAUBENDREHER
TOURNEVIS DISSIPATIFS
DESTORNILLADORES ANTIESTATICOS



1 Ergonomic tri-lobe handle design for comfort & effective delivery of torque

Ergonomischer dreiflügeliger Griff für Komfort und erhöhtem Drehmoment

Manche de conception ergonomique à trois lobes pour le confort et pour une transmission efficace du couple
Diseño del mango trilobulado y ergonómico para una aplicación cómoda y eficaz del par

2 Fully ESD compliant for safe use on sensitive electronic components

Vollständig ESD-konform, ableitfähig in allen Bereichen
Entièrement conformes ESD pour une utilisation en toute sécurité sur les composants électroniques sensibles
Cumple por completo la normativa eléctrica para ESD, para uso seguro con componentes electrónicos sensibles

3 Toughened alloy steel blade for exceptional strength & durability

Gehärteter Schaft aus legiertem Stahl für außergewöhnliche Festigkeit und Langlebigkeit
Lame en acier allié durci pour une résistance et une durabilité exceptionnelles
Hoja de aleación de acero y templado para obtener una resistencia y una durabilidad excepcionales

4 Black anti-peel finish eliminates the risk of damage from flaking chrome

Schwarze Klingen, vermeiden Reflexe und Abblättern von Chrompartikeln
La finition noire anti-écaillage élimine le risque de dommages dus à l'écaillage du chrome
El acabado elimina el riesgo de descascarillarse el cromo

5 Handle injection moulded directly to blade giving the ultimate bond for increased reliability & durability

Direkter Spritzguss des Griffs mit dem Schaft garantiert langlebige Verbindung und Funktion
Manche moulé par injection directement sur la lame, gage de la meilleure des adhérences pour une fiabilité et une durabilité accrues
Mango de inyección moldeado directamente en la varilla proporcionando el refuerzo fundamental para una mayor fiabilidad y durabilidad

6 Precision machined tip for an exact screw fit & damage free screwdriving

Paßgenaue Spitze für beschädigungsfreies Eindrehen
Pointe à usinage de précision pour un logement exact dans la tête de vis et un vissage sans dommages
Punta mecanizada de precisión para el ajuste exacto del tornillo y sin causar daños al atornillar

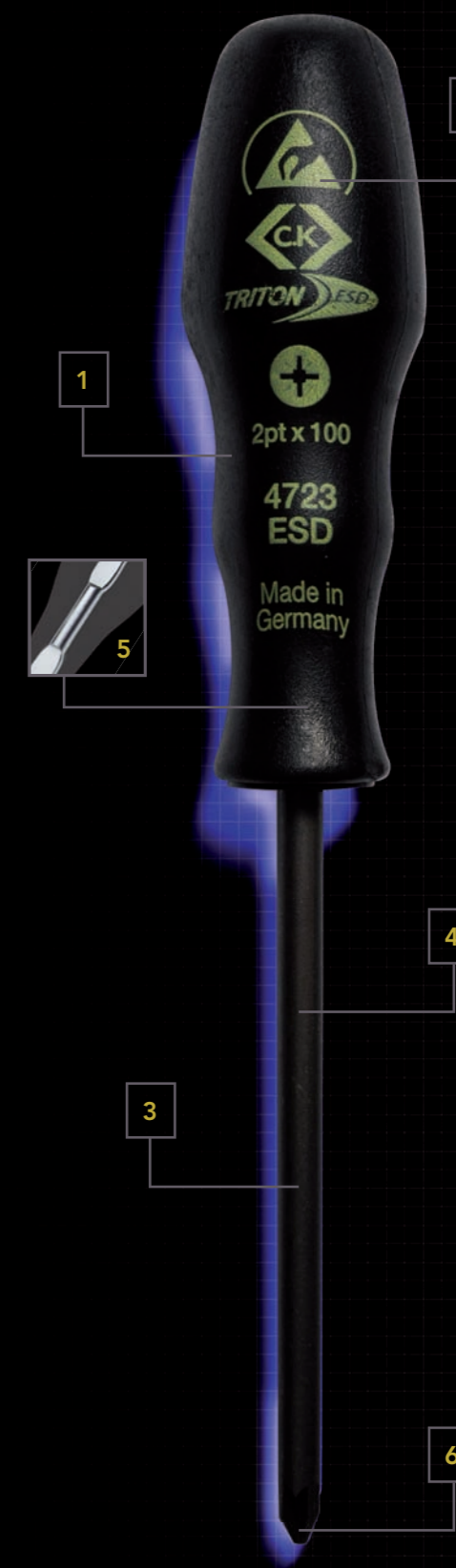

TRITON ESD SCREWDRIVERS



Screwdriver - Slotted parallel

BS EN 61340 2, ISO 2380-2, DIN 5264

| Item Number | + | Ø | → | ← | ⊞ |
|-------------|-----------|-----------|--------------|-------------|---|
| T4725ESD 03 | 3mm 1/8" | 75mm 3" | 0.5mm 0.02" | 70mm 2 3/4" | 6 |
| T4725ESD 04 | 3mm 1/8" | 100mm 4" | 0.5mm 0.02" | 80mm 3 1/8" | 6 |
| T4725ESD 41 | 4mm 5/32" | 100mm 4" | 0.8mm 0.031" | 90mm 3 1/2" | 6 |
| T4725ESD 05 | 5mm 3/16" | 125mm 5" | 0.8mm 0.031" | 90mm 3 1/2" | 6 |
| T4725ESD 10 | 5mm 3/16" | 250mm 10" | 0.8mm 0.031" | 90mm 3 1/2" | 6 |



Screwdriver - PZ

BS EN 61340 2, ISO 8764

| Item Number | + | Ø | → | ← | ⊞ |
|-------------|-----|-------------|-------------|-------------|---|
| T4723ESD 0 | PZ0 | 3.5mm 5/16" | 60mm 2 1/8" | 70mm 2 3/4" | 6 |
| T4723ESD 1 | PZ1 | 5.0mm 3/16" | 80mm 3 1/8" | 90mm 3 1/2" | 6 |
| T4723ESD 2 | PZ2 | 6.0mm 7/32" | 100mm 4" | 100mm 4" | 6 |



Screwdriver - PH

BS EN 61340 2, ISO 2380-2, DIN 5264

| Item Number | + | Ø | → | ← | ⊞ |
|-------------|-----|-------------|-------------|-------------|---|
| T4722ESD 0 | PH0 | 3.5mm 5/16" | 60mm 2 1/8" | 70mm 2 3/4" | 6 |
| T4722ESD 1 | PH1 | 5.0mm 3/16" | 80mm 3 1/8" | 90mm 3 1/2" | 6 |
| T4722ESD 13 | PH1 | 5.0mm 3/16" | 300mm 12" | 90mm 3 1/2" | 6 |
| T4722ESD 2 | PH2 | 6.0mm 7/32" | 100mm 4" | 100mm 4" | 6 |
| T4722ESD 23 | PH2 | 6.0mm 7/32" | 300mm 12" | 100mm 4" | 6 |



Screwdriver - TX tamperproof

BS EN 61340 2, ISO 2380-2, DIN 5264

| Item Number | + | Ø | → | ← | ⊞ |
|---------------|------|-------------|-------------|-------------|---|
| T4718ESD 08 | T 08 | 3.0mm 1/8" | 70mm 2 3/4" | 80mm 3 1/8" | 6 |
| T4718ESD 0820 | T 08 | 3.0mm 1/8" | 200mm 8" | 80mm 3 1/8" | 6 |
| T4718ESD 09 | T 09 | 3.0mm 1/8" | 70mm 2 3/4" | 80mm 3 1/8" | 6 |
| T4718ESD 10 | T 10 | 3.0mm 1/8" | 80mm 3 1/8" | 90mm 3 1/2" | 6 |
| T4718ESD 1030 | T 10 | 3.0mm 1/8" | 300mm 12" | 90mm 3 1/2" | 6 |
| T4718ESD 15 | T 15 | 3.5mm 5/16" | 80mm 3 1/8" | 90mm 3 1/2" | 6 |
| T4718ESD 1530 | T 15 | 3.5mm 5/16" | 300mm 12" | 90mm 3 1/2" | 6 |
| T4718ESD 20 | T 20 | 4.0mm 5/16" | 90mm 3 1/2" | 90mm 3 1/2" | 6 |



Screwdriver bit driver

BS EN 61340 2

| Item Number | i | Ø | → | ← | ⊞ |
|-------------|------------|------------|----------|----------|---|
| T4582ESD | C 6.3 1/4" | 11mm 7/16" | 125mm 5" | 100mm 4" | 6 |

CONTENTS: 1 x slotted, sizes: 3 x 75, 3 x 100 & 5 x 135mm.
1 x PZ, sizes: 0 x 60, 1 x 80 & 2 x 100mm.



Screwdriver set - 6 Piece SL/PZ

BS EN 61340 2

| Item Number | ⊞ |
|-------------|---|
| T4741ESD | 3 |

CONTENTS: 1 x slotted, sizes: 3 x 75, 3 x 100 & 5 x 135mm.
1 x PH, sizes: 0 x 60, 1 x 80 & 2 x 100mm.



Screwdriver set - 6 Piece SL/PH

BS EN 61340 2

| Item Number | ⊞ |
|-------------|---|
| T4741SESD | 3 |

CONTENTS: 1 x TX, sizes: 8, 9, 10, 15 & 20.



Screwdriver set - 5 Piece TX

| Item Number | ⊞ |
|-------------|---|
| T4730ESD | 3 |

- Long reach screwdrivers

CONTENTS: 1 x slotted, size: 5 x 250mm. 1 x PH, sizes: 1 x 300 & 2 x 300mm. 1 x TX, sizes: 8 x 200, 10 x 300 & 15 x 300mm.



Screwdriver set - 6 Piece SL/PH/TX

BS EN 61340 2

| Item Number | ⊞ |
|-------------|---|
| T4797ESD | 3 |

XONIC

PRECISION SCREWDRIVERS

PRÄZISIONSSCHRAUBENDREHER
TOURNEVIS DE PRÉCISION
DESTORNILLADORES DE PRECISIÓN



1 Ergonomically designed handle with hollow rotating cap for ease of use & precise control

Ergonomisch gestalteter Griff mit drehbarer Muldenkappe für optimale Kontrolle der Drehbewegung auch bei kleinsten Drehmomenten
Manche de conception ergonomique avec virole creuse pour la facilité d'utilisation et la précision de positionnement
Mango de diseño ergonómico con extremo giratorio hueco para facilitar el uso y para el control de precisión

2 Premium quality chrome vanadium steel blade for exceptional strength & durability

Hochqualitativer Chrom-Vanadiumstahlschaft für außergewöhnliche Festigkeit und Dauerhaftigkeit
Lame en acier au chrome-vanadium de première qualité pour une résistance et une durabilité exceptionnelles
Cuchilla de acero al cromo vanadio de alta calidad para una resistencia y durabilidad excepcionales

3 Precision machined tip for an exact screw fit & damage free screwdriving

Paßgenaue Spitzen für exakte Anpassungen und beschädigungsfreies Eindrehen
Pointe à usinage de précision pour un logement exact dans la tête de vis et un vissage sans dommages
Punta mecanizada de precisión para el ajuste exacto del tornillo y sin causar daños al atornillar

4 Black anti-peel tips eliminates the risk of damage from flaking chrome

Schwarze Klingen, nicht verchromt, vermeiden Reflexe und Abblättern von Chrompartikeln
Les pointes noires anti-écaillage éliminent le risque de dommages dus à l'écaillage du chrome
El acabado elimina el riesgo de descascarillarse el cromo

5 Tip type colour coding for easy identification

Farbcodierte Muldenkappen zur einfachen Erkennung
Codage couleur du type de pointe pour une identification aisée
Código de colores para el tipo de punta para una fácil identificación



XONIC™

XONIC SCREWDRIVERS



Screwdriver - Slotted parallel

| Item Number | Tip | Blade Length | Blade Width | Blade Thickness | Blade Depth | Blade Height | Blade Volume |
|-------------|-------------|--------------|---------------|-----------------|-------------|--------------|--------------|
| T4880X 08 | 0.8mm 1/32" | 60mm 2 3/8" | 0.20mm 0.008" | 97mm 3 3/16" | 30 | | |
| T4880X 12 | 1.2mm 3/64" | 60mm 2 3/8" | 0.20mm 0.008" | 97mm 3 3/16" | 30 | | |
| T4880X 15 | 1.5mm 1/16" | 60mm 2 3/8" | 0.25mm 0.010" | 97mm 3 3/16" | 30 | | |
| T4880X 18 | 1.8mm 3/64" | 60mm 2 3/8" | 0.30mm 0.012" | 97mm 3 3/16" | 30 | | |
| T4880X 256 | 2.5mm 3/32" | 60mm 2 3/8" | 0.40mm 0.016" | 97mm 3 3/16" | 30 | | |
| T4880X 257 | 2.5mm 3/32" | 75mm 3" | 0.40mm 0.016" | 97mm 3 3/16" | 30 | | |
| T4880X 310 | 3.0mm 1/8" | 100mm 4" | 0.50mm 0.020" | 97mm 3 3/16" | 20 | | |
| T4880X 315 | 3.0mm 1/8" | 150mm 6" | 0.50mm 0.020" | 97mm 3 3/16" | 10 | | |
| T4880X 410 | 4.0mm 5/32" | 100mm 4" | 0.80mm 0.031" | 97mm 3 3/16" | 30 | | |
| T4880X 415 | 4.0mm 5/32" | 150mm 6" | 0.80mm 0.031" | 97mm 3 3/16" | 10 | | |



Screwdriver - PH

| Item Number | Tip | Blade Length | Blade Width | Blade Thickness | Blade Depth | Blade Height | Blade Volume |
|-------------|-------|--------------|-------------|-----------------|-------------|--------------|--------------|
| T4882X 000 | PH000 | 2.5mm 3/32" | 60mm 2 3/8" | 97mm 3 3/16" | 30 | | |
| T4882X 00 | PH00 | 2.5mm 3/32" | 60mm 2 3/8" | 97mm 3 3/16" | 10 | | |
| T4882X 0 | PH0 | 3.0mm 1/8" | 60mm 2 3/8" | 97mm 3 3/16" | 10 | | |
| T4882X 1 | PH1 | 4.5mm 11/64" | 80mm 3 1/8" | 97mm 3 3/16" | 30 | | |



Screwdriver - TX

| Item Number | Tip | Blade Length | Blade Width | Blade Thickness | Blade Depth | Blade Height | Blade Volume |
|-------------|------|--------------|-------------|-----------------|-------------|--------------|--------------|
| T4877X 04 | T 04 | 2.5mm 3/32" | 50mm 2" | 97mm 3 3/16" | 30 | | |
| T4877X 05 | T 05 | 2.5mm 3/32" | 50mm 2" | 97mm 3 3/16" | 30 | | |
| T4877X 06 | T 06 | 3.5mm 9/64" | 50mm 2" | 97mm 3 3/16" | 30 | | |
| T4877X 07 | T 07 | 3.5mm 9/64" | 50mm 2" | 97mm 3 3/16" | 30 | | |
| T4877X 08 | T 08 | 3.5mm 9/64" | 60mm 2 3/8" | 97mm 3 3/16" | 30 | | |
| T4877X 09 | T 09 | 4.0mm 5/32" | 60mm 2 3/8" | 97mm 3 3/16" | 30 | | |
| T4877X 10 | T 10 | 4.0mm 5/32" | 80mm 3 1/8" | 97mm 3 3/16" | 30 | | |
| T4877X 15 | T 15 | 4.0mm 5/32" | 80mm 3 1/8" | 97mm 3 3/16" | 30 | | |

CONTENTS: 1 x slotted, sizes: 2.5 x 75, 3 x 100, 3 x 150, 4 x 100 & 4 x 150mm. 1 x PH, sizes: 0 x 60 & 1 x 80mm.



Screwdriver set - 7 Piece SL/PH

| Item Number | Quantity |
|-------------|----------|
| T4883X | 1 |

CONTENTS: 1 x slotted, sizes: 2.5 x 75, 3.0 x 100 & 4.0 x 100mm. 1 x PH, sizes: 00 x 60 & 0 x 60mm.



Screwdriver set - 5 Piece SL/PH

| Item Number | Quantity |
|-------------|----------|
| T4880X/5 | 1 |

CONTENTS: 1 x slotted, sizes: 1.8 x 60, 3.0 x 100 & 4.0 x 150mm. 1 x PH, size: 0 x 60mm.



Screwdriver set - 4 Piece SL/PH

| Item Number | Quantity |
|-------------|----------|
| T4884X | 1 |

CONTENTS: 1 x hexagon, sizes: 0.7 x 50, 0.9 x 50, 1.3 x 50, 1.5 x 50, 2.0 x 50, 2.5 x 60 & 3.0 x 60mm.



**Screwdriver Set -
7 Piece Hexagon**

| | |
|-------------|---|
| Item Number | |
| T4874X | 1 |

CONTENTS: 1 x TX, sizes: 6, 7, 8, 9, 10, 15 & 20.



**Screwdriver set -
7 Piece Torx**

| | |
|-------------|---|
| Item Number | |
| T4877PX | 1 |

**PRECISION SCREWDRIVER
SETS**

CONTENTS: 1 x screwdriver, slotted, sizes: 1.0 x 15, 1.6 x 20, 2.0 x 22 & 2.4 x 25mm.



**Screwdriver set -
4 Piece slotted**

| | |
|-------------|---|
| Item Number | |
| T4852P | 6 |

- Blades manufactured from special alloy steel for strength & durability
- Precision machined tips for an exact screw fit

CONTENTS: 1 x screwdriver, slotted, sizes: 1.0 x 15, 1.6 x 20, 2.0 x 22 & 2.4 x 25mm. 1 x PH, sizes: 00 x 25 & 0 x 25mm.



**Screwdriver Set -
6 Piece SL/PH**

| | |
|-------------|---|
| Item Number | |
| T4854P | 6 |

- Ergonomically designed handle with hollow rotating cap for ease of use & precise control
- Interchangeable double ended blades manufactured from premium quality chrome vanadium/molybdenum steel for strength & durability
- Precision machined tips for an exact screw fit

CONTENTS: Screwdriver handle. 1 x double ended blades, sizes: slotted 1.5mm x PH000, slotted 2.0mm x PH00, slotted 3.0 x PH0, slotted 4.0mm x PH1, 1 x TX; sizes 5, 6, 7 & 8.



**Screwdriver set -
7 Piece SL/PH/TX**

| | |
|-------------|---|
| Item Number | |
| T4896 | 6 |

**XONIC ESD
DISSIPATIVE PRECISION SCREWDRIVERS**
ABLEITFÄHIGE PRÄZISIONSSCHRAUBENDREHER
TOURNEVIS DISSIPATIFS DE PRÉCISION
DESTORNILLADORES DE PRECISIÓN DISIPANTES



1 Ergonomically designed handle with hollow rotating cap for ease of use & precise control

Ergonomisch gestalteter Griff mit drehbarer Muldenkappe garantiert optimale Kontrolle der Drehbewegung auch bei kleinsten Drehmomenten

Manche de conception ergonomique avec virole creuse pour la facilité d'utilisation et la précision de positionnement

Mango de diseño ergonómico con extremo giratorio hueco para facilitar el uso y para el control de precisión

2 Premium quality alloy steel blade for exceptional strength & durability

Hochqualitativer Schaft aus legiertem Stahl für außergewöhnliche Festigkeit und Dauerhaftigkeit

Lame en acier au chrome-vanadium de première qualité pour une résistance et une durabilité exceptionnelles

Cuchilla de aleación de acero de alta calidad para una resistencia y durabilidad excepcionales

3 Precision machined tip for an exact screw fit & damage free screwdriving

Paßgenaue Spitzen für beschädigungsfreies Eindrehen

Pointe à usinage de précision pour un logement exact dans la tête de vis et un vissage sans dommages

Punta mecanizada de precisión para el ajuste exacto del tornillo y sin causar daños al atornillar

4 Black anti-peel tips eliminates the risk of damage from flaking chrome

Schwarze Klingen, vermeiden Reflexe und Abblättern von Chrompartikeln

Les pointes noires anti-écaillage éliminent le risque de dommages dus à l'écaillage du chrome

El acabado antidescamado elimina el riesgo de descamación del cromo

5 Fully ESD compliant for safe use on sensitive electronic components

Vollständig ESD-konform, ableitfähig in allen Bereichen

Entièrement conformes ESD pour une utilisation en toute sécurité sur les composants électroniques sensibles

Cumple por completo la normativa eléctrica para ESD, para uso seguro con componentes electrónicos sensibles



XONIC ESD SCREWDRIVERS



Screwdrivers - Slotted parallel

BS EN 61340 2

| Item Number | Tip | Length | Width | Shank | Tip Length | Tip Width | Quantity |
|-------------|-------------|-------------|---------------|--------------|------------|-----------|----------|
| T4880XES08 | 0.8mm 1/32" | 60mm 2 3/8" | 0.20mm 0.008" | 97mm 3 3/16" | 30 | | |
| T4880XES12 | 1.2mm 3/64" | 60mm 2 3/8" | 0.25mm 0.010" | 97mm 3 3/16" | 30 | | |
| T4880XES15 | 1.5mm 1/16" | 60mm 2 3/8" | 0.30mm 0.012" | 97mm 3 3/16" | 30 | | |
| T4880XES18 | 1.8mm 3/64" | 60mm 2 3/8" | 0.30mm 0.012" | 97mm 3 3/16" | 30 | | |
| T4880XES256 | 2.5mm 3/32" | 60mm 2 3/8" | 0.40mm 0.016" | 97mm 3 3/16" | 30 | | |
| T4880XES257 | 2.5mm 3/32" | 75mm 3" | 0.40mm 0.016" | 97mm 3 3/16" | 30 | | |
| T4880XES310 | 3.0mm 1/8" | 100mm 4" | 0.50mm 0.020" | 97mm 3 3/16" | 30 | | |
| T4880XES315 | 3.0mm 1/8" | 150mm 6" | 0.50mm 0.020" | 97mm 3 3/16" | 30 | | |
| T4880XES410 | 4.0mm 5/32" | 100mm 4" | 0.60mm 0.024" | 97mm 3 3/16" | 30 | | |
| T4880XES415 | 4.0mm 5/32" | 150mm 6" | 0.60mm 0.024" | 97mm 3 3/16" | 30 | | |



Screwdrivers - PZ

BS EN 61340 2

| Item Number | Tip | Length | Width | Shank | Tip Length | Tip Width | Quantity |
|--------------|-----|------------|-------------|--------------|------------|-----------|----------|
| T4875X ESD | PZ0 | 3.0mm 1/8" | 60mm 2 3/8" | 97mm 3 3/16" | 30 | | |
| T4875X ESD 1 | PZ1 | 4.5mm 1/4" | 80mm 3 1/8" | 97mm 3 3/16" | 30 | | |



Screwdrivers - PH

BS EN 61340 2

| Item Number | Tip | Length | Width | Shank | Tip Length | Tip Width | Quantity |
|--------------|-------|-------------|-------------|--------------|------------|-----------|----------|
| T4882X000ES | PH000 | 2.5mm 3/32" | 60mm 2 3/8" | 97mm 3 3/16" | 30 | | |
| T4882X000ESD | PH00 | 2.5mm 3/32" | 60mm 2 3/8" | 97mm 3 3/16" | 30 | | |
| T4882X0 ESD | PH0 | 3.0mm 1/8" | 60mm 2 3/8" | 97mm 3 3/16" | 30 | | |
| T4882X1 ESD | PH1 | 4.5mm 1/4" | 80mm 3 1/8" | 97mm 3 3/16" | 30 | | |



Screwdrivers - TX

BS EN 61340 2

| Item Number | Tip | Length | Width | Shank | Tip Length | Tip Width | Quantity |
|-------------|------|-------------|-------------|--------------|------------|-----------|----------|
| T4877XESD04 | T 04 | 2.5mm 3/32" | 50mm 2" | 97mm 3 3/16" | 30 | | |
| T4877XESD05 | T 05 | 2.5mm 3/32" | 50mm 2" | 97mm 3 3/16" | 30 | | |
| T4877XESD06 | T 06 | 3.5mm 9/64" | 50mm 2" | 97mm 3 3/16" | 30 | | |
| T4877XESD07 | T 07 | 3.5mm 9/64" | 50mm 2" | 97mm 3 3/16" | 30 | | |
| T4877XESD08 | T 08 | 3.5mm 9/64" | 60mm 2 3/8" | 97mm 3 3/16" | 30 | | |



Screwdrivers - Hexagon, ball end

BS EN 61340 2

| Item Number | Tip | Length | Width | Shank | Tip Length | Tip Width | Quantity |
|-------------|-------------|-------------|-------------|--------------|------------|-----------|----------|
| T4838XESD15 | 3.2mm 1/8" | 50mm 2" | 2.5mm 3/32" | 97mm 3 3/16" | 30 | | |
| T4838XESD20 | 3.5mm 9/64" | 50mm 2" | 2.5mm 3/32" | 97mm 3 3/16" | 30 | | |
| T4838XESD25 | 4.0mm 5/32" | 60mm 2 3/8" | 3.0mm 1/8" | 97mm 3 3/16" | 30 | | |
| T4838XESD30 | 4.5mm 1/4" | 60mm 2 3/8" | 3.5mm 9/64" | 97mm 3 3/16" | 30 | | |



Nut driver

BS EN 61340 2

| Item Number | Tip | Length | Width | Shank | Tip Length | Tip Width | Quantity |
|-------------|-------------|-------------|-----------|--------------|------------|-----------|----------|
| T4840XESD32 | 3.2mm 1/8" | 60mm 2 3/8" | 4mm 5/32" | 97mm 3 3/16" | 30 | | |
| T4840XESD35 | 3.5mm 9/64" | 60mm 2 3/8" | 4mm 5/32" | 97mm 3 3/16" | 30 | | |
| T4840XESD40 | 4.0mm 5/32" | 60mm 2 3/8" | 4mm 5/32" | 97mm 3 3/16" | 30 | | |
| T4840XESD45 | 4.5mm 1/4" | 60mm 2 3/8" | 4mm 5/32" | 97mm 3 3/16" | 30 | | |
| T4840XESD50 | 5.0mm 3/16" | 60mm 2 3/8" | 4mm 5/32" | 97mm 3 3/16" | 30 | | |
| T4840XESD55 | 5.5mm 7/32" | 60mm 2 3/8" | 4mm 5/32" | 97mm 3 3/16" | 30 | | |

CONTENTS: 1 x slotted, sizes: 2.5 x 75, 3.0 x 100, 3.0 x 150, 4.0 x 100 & 4.0 x 150mm. 1 x PH, sizes: 0 x 60 & 1 x 80mm.



Screwdriver set - 7 Piece SL/PH

Item Number

T4883XESD

CONTENTS: 1 x slotted, sizes: 1.8 x 60, 3 x 100 & 4 x 150mm. 1 x PH, size: 0 x 60mm.



Screwdriver set - 4 Piece SL/PH

Item Number

T4884XESD

CERAMIC TRIMMERS

- Zirconia ceramic tips - safe trimming of highly sensitive electrical components, highly acid resistant (other than Hydrofluoric), solder repellent & electrically non-conductive
- Heat resistant up to 1000°C for safe use
- Non-magnetic to prevent electro-magnetic damage



Ceramic trimmers - Slotted

| Item Number | Tip | Length | Width | Shank | Tip Length | Tip Width | Quantity |
|-------------|--------------|-----------|--------------|-------------|------------|-----------|----------|
| T4845 09 | 0.9mm 0.035" | 15mm 5/8" | 0.4mm 0.016" | 85mm 3 3/8" | 10 | | |
| T4845 13 | 1.3mm 0.051" | 15mm 5/8" | 0.4mm 0.016" | 85mm 3 3/8" | 10 | | |
| T4845 18 | 1.8mm 0.071" | 15mm 5/8" | 0.4mm 0.016" | 85mm 3 3/8" | 10 | | |
| T4845 26 | 2.6mm 0.102" | 15mm 5/8" | 0.4mm 0.016" | 85mm 3 3/8" | 10 | | |



Ceramic trimmers - PH

| Item Number | Tip | Length | Width | Shank | Tip Length | Tip Width | Quantity |
|-------------|-------------|--------------|-----------|-------------|------------|-----------|----------|
| T4847 | PH0 | 2.6mm 0.102" | 15mm 5/8" | 85mm 3 3/8" | 10 | | |
| T4847 0 | PH0 special | 2.6mm 0.102" | 15mm 5/8" | 85mm 3 3/8" | 10 | | |

- 2 reversible double blade inserts



Ceramic trimmers - 4 in 1

| Item Number | A | B | C | D | Quantity |
|-------------|--------------|-------------|--------------|--------------|----------|
| T4856 | 0.9mm 0.035" | PH0 special | 1.8mm 0.071" | PH0 | 10 |
| T4856 A | 0.9mm 0.035" | PH0 special | 1.8mm 0.071" | 2.6mm 0.102" | 10 |

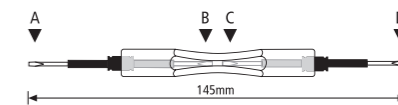

PLASTIC TRIMMERS



Plastic trimmer set - 7 Piece

| Item Number | | | | | |
|-------------|---|--------------|--------------|-------------|-------------|
| T4844 | | | | 1 | |
| i | | | | | |
| | P | 0.5mm 0.020" | 1.2mm 0.047" | 65mm 2 1/2" | 85mm 3 3/8" |
| | P | 0.5mm 0.020" | 1.5mm 0.047" | 65mm 2 1/2" | 85mm 3 3/8" |
| | P | 0.7mm 0.028" | 2.4mm 0.094" | 65mm 2 1/2" | 85mm 3 3/8" |
| | B | 0.5mm 0.020" | 1.0mm 0.039" | 65mm 2 1/2" | 85mm 3 3/8" |
| | B | 0.5mm 0.020" | 2.0mm 0.079" | 65mm 2 1/2" | 85mm 3 3/8" |
| | B | 0.7mm 0.028" | 1.5mm 0.059" | 65mm 2 1/2" | 85mm 3 3/8" |
| | B | 0.7mm 0.028" | 2.5mm 0.098" | 65mm 2 1/2" | 85mm 3 3/8" |

P = Plastic B = Brass



Plastic trimmer set - 10 Piece

| Item Number | | | |
|-------------|---------------|---|-------|
| T4857 | | 3 | |
| | | i | |
| | 0.7mm x 1.0mm | | 1.4mm |
| | 0.5mm x 1.3mm | | 1.8mm |
| | 0.8mm x 2.3mm | | 2.5mm |
| | 0.7mm x 2.0mm | | 4mm |
| | 0.7mm x 2.4mm | | 5mm |
| | 1.3mm | | 3mm |
| | 0.7mm x 1.0mm | | 3mm |
| | 0.8mm x 1.3mm | | 3mm |
| | 0.8mm x 1.8mm | | 3mm |
| | 0.7mm x 2.4mm | | 4mm |

POINT OF SALE

VERKAUFSBEREICH
MATERIAL PLV
PUNTO DE VENTA

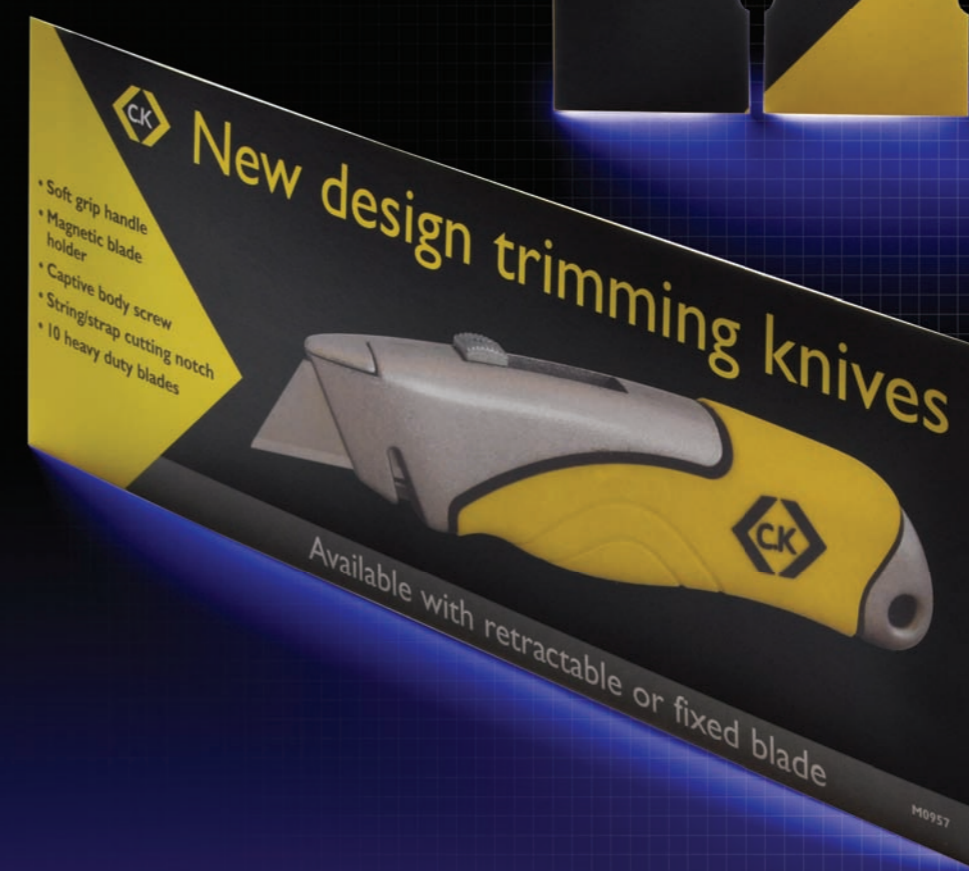



Highlighter card
Redline VDE pliers range

| | | |
|-------------|-------------|---|
| Item Number | 450 x 540mm | 1 |
| M0017 | | |



Highlighter card
Redline VDE Combicutter range

| | | |
|-------------|-------------|---|
| Item Number | 220 x 550mm | 1 |
| M39071 | | |



Highlighter card
Redline VDE Combicutter3™

| | | |
|-------------|-------------|---|
| Item Number | 160 x 260mm | 1 |
| M0014 | | |



Highlighter card
Redline VDE Combicutter3MAX™

| | | |
|-------------|-------------|---|
| Item Number | 160 x 280mm | 1 |
| M39072 | | |



Highlighter card
RedLine VDE Electrician's pliers

| | | |
|-------------|-------------|---|
| Item Number | 160 x 280mm | 1 |
| M39077HIE | | |



Highlighter card
Ratchet crimping pliers range

| | | |
|-------------|-------------|---|
| Item Number | 545 x 475mm | 1 |
| M3680 | | |



Highlighter card
Universal switch key

| | | |
|-------------|-------------|---|
| Item Number | 225 x 210mm | 1 |
| M4451 | | |



Highlighter card
Claw hammers - Anti-vibration forged

| | | | |
|-------------|-------------|-----------------------|---|
| Item Number | 150 x 180mm | Compatible with M0104 | 1 |
| M0109 | | | |



Highlighter card
Club hammer - Anti-vibration

| | | | |
|-------------|-------------|-----------------------|---|
| Item Number | 150 x 180mm | Compatible with M0104 | 1 |
| M0111 | | | |



Highlighter card
Claw hammers - Anti-vibration fibreglass

| | | | |
|-------------|-------------|-----------------------|---|
| Item Number | 150 x 180mm | Compatible with M0104 | 1 |
| M0110 | | | |



Highlighter card
Claw hammers - Hi-vis

| | | | |
|-------------|-------------|-----------------------|---|
| Item Number | 150 x 180mm | Compatible with M0104 | 1 |
| M0112 | | | |



Header card Spirit level

| | | |
|-------------|-------------|---|
| Item Number | 300 x 210mm | 1 |
| M3494 | | |



Dump bin
Sabretooth saw

| | | |
|-------------|--------------------|---|
| Item Number | ←————→ | 📦 |
| M8100 | 500 x 500 x 1250mm | 1 |



Pallet sleeve
Sabretooth saw

| | | |
|-------------|---------------------|---|
| Item Number | ←————→ | 📦 |
| M8101 | 1000 x 1200 x 800mm | 1 |



Poster Sabretooth saw

| | | |
|-------------|------------------|---|
| Item Number | ←————→ | 📦 |
| M8102 | A3 (297 x 420mm) | 1 |



Header card Trimming knife

| | | |
|-------------|-------------|---|
| Item Number | ←————→ | 📦 |
| M0957 | 310 x 120mm | 1 |



Header card
Trimming knife blade

| | | |
|-------------|-------------|---|
| Item Number | ←————→ | 📦 |
| M0959 | 310 x 120mm | 1 |



Single highlighter card
Fast4 drill bits

| | | |
|-------------|-------------|---|
| Item Number | ←————→ | 📦 |
| M2943-2 | 160 x 280mm | 1 |



Range highlighter card
Fast4 drill bits

| | | |
|-------------|-------------|---|
| Item Number | ←————→ | 📦 |
| M2943-1 | 230 x 600mm | 1 |

MERCHANDISING

ABSATZFÖRDERUNG
MERCHANDISING
COMERCIALIZACIÓN



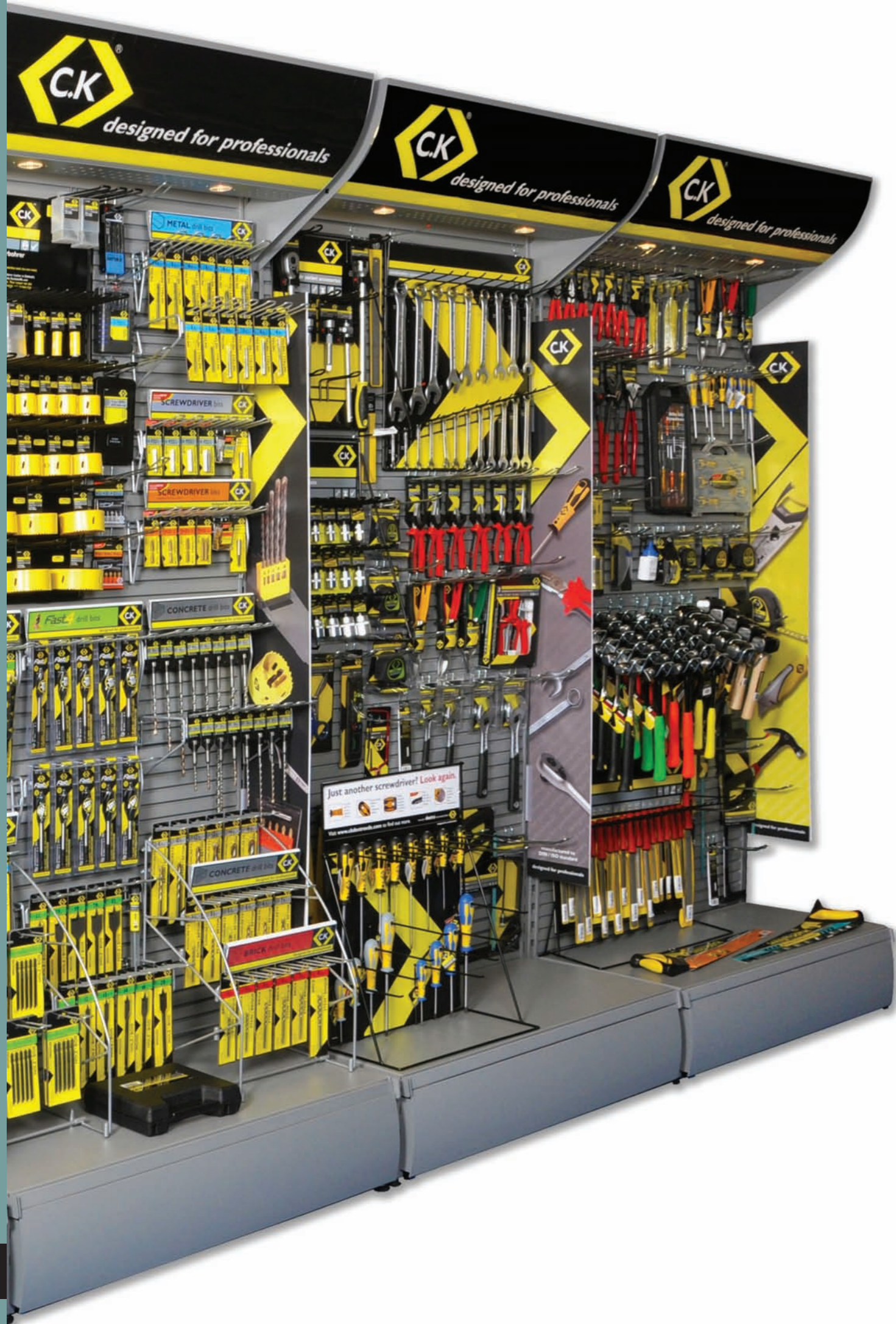

STRIKING DISPLAYS

Progressive and eye-catching display units have been created to maximise impact in-store, helping to generate incremental sales and encouraging impulse purchases.





1 METRE SLAT WALL DISPLAYS

Every market is different, that's why we offer a choice of suggested stock profiles which can be easily adapted to suit your particular business.

- Electrical wholesale
- Engineer's merchants
- DIY / hardware
- Builder's merchants
- Power tool accessories - Electrical wholesale
- Power tool accessories - Builder's merchants

Dimensions - 1m slat wall display:
W 100cm x H 210cm x D 70cm

ALPHABETICAL INDEX

| PRODUCT | PAGE NUMBER | PRODUCT | PAGE NUMBER |
|--------------------------------|------------------------|--------------------------|---|
| Adhesive trowels | 72 | Coping saw | 89 |
| Adjustable wrenches | 101 | Countersink bits | 123 |
| Auger bits | 122 | Crimping pliers | 21-22 |
| Automatic wire/cable strippers | 53-55, 156 | Crowbars | 63 |
| Jokari | 53-54 | Cutters | 10-11, 15, 18, 25-27, 71, 110-111, 147-148, 152-153 |
| Ball pein hammer | 62, 109 | Bolt | 27 |
| Ball pen | 162 | Cable & wire rope cutter | 27 |
| ESD | 162 | Cable | 11, 15 |
| Basin wrench | 70 | RedLine | 15 |
| Bolsters | 64 | RedLine VDE | 11 |
| Brick | 64 | Multi cutter | 25 |
| Electrician's | 64 | Oblique | 147-148, 153 |
| Bolt cutters | 27 | Classic | 153 |
| Bradawls | 47 | SensoplusESD | 147-148 |
| Brick hammers | 62 | PVC pipe | 25, 71 |
| Brick jointer | 68 | Side | 10-11, 15, 18, 147-148, 152-153 |
| Broad heel trowels | 66 | Classic | 18, 152-153 |
| Cable & wire rope cutter | 27 | RedLine | 15 |
| Cable & wire strippers | 10, 13, 16, 53-55, 156 | RedLine VDE | 10-11 |
| Jokari | 53-54 | SensoplusESD | 147-148 |
| Precision | 156 | Snips | 110-111 |
| RedLine | 16 | Top | 26, 153 |
| RedLine VDE | 10, 13 | Classic | 153 |
| Cable cutters | 11, 15 | Wire | 27 |
| RedLine | 15 | Damaged screw removers | 131 |
| RedLine VDE | 11 | Desoldering tools | 162 |
| Cable knives | 52-53 | ESD | 162 |
| Jokari | 52-53 | Draw tapes | 56 |
| Cable shears | 11, 15 | Drill bits | 114-123 |
| Cable snips | 56 | Accessories | 123 |
| Cable tie gun | 56 | Brick | 116 |
| Carpenter's pencil | 84 | Straight shank | 116 |
| Centre punches | 109 | Concrete | 114-115 |
| Chain saw files | 107 | SDS-Plus | 114-115 |
| Chalk line reels | 83 | Straight shank | 115 |
| Chalk lines | 83 | Metal | 116-119 |
| Chalk powders | 83 | Multistep | 119 |
| Chisels | 64-65, 93 | Multi-purpose | 119 |
| Cold | 64 | Sets | 114-119, 121 |
| Displays | 65 | Brick | 116 |
| Plugging | 64 | Combination | 119 |
| Scutch | 65 | Concrete | 114-115 |
| Sets | 93 | Metal | 117-118 |
| Sharpening stone | 93 | Multi-purpose | 119 |
| Wood | 93 | Wood | 121 |
| Circlip pliers | 23 | Wood | 121-123 |
| Claw hammer | 61 | Auger | 122 |
| Club hammer | 61 | Brad point | 121 |
| Combination pliers | 13, 15, 18 | Fast4 | 120-121 |
| Classic | 18 | Fast4 SDS-Plus | 121 |
| RedLine | 15 | Flat | 123 |
| RedLine VDE | 13 | Drill mixers | 69 |
| Combination spanners | 100-101 | Drill saw | 119 |
| Combination squares | 85 | Dry wall saw | 90 |
| | | Edging trowel | 67 |
| | | Electrician's scissors | 56 |
| | | Engineer's files | 106 |

SCREWDRIVER MERCHANDISING

Our stylish merchandising system is infinitely flexible and can be used with existing slat wall or peg metal displays, as a counter display unit or as a dedicated single or double sided free standing display.

Dimensions - single side screwdriver display:
W 50cm x H 160cm x D 40cm

Dimensions - double side screwdriver display:
W 50cm x H 160cm x D 70cm

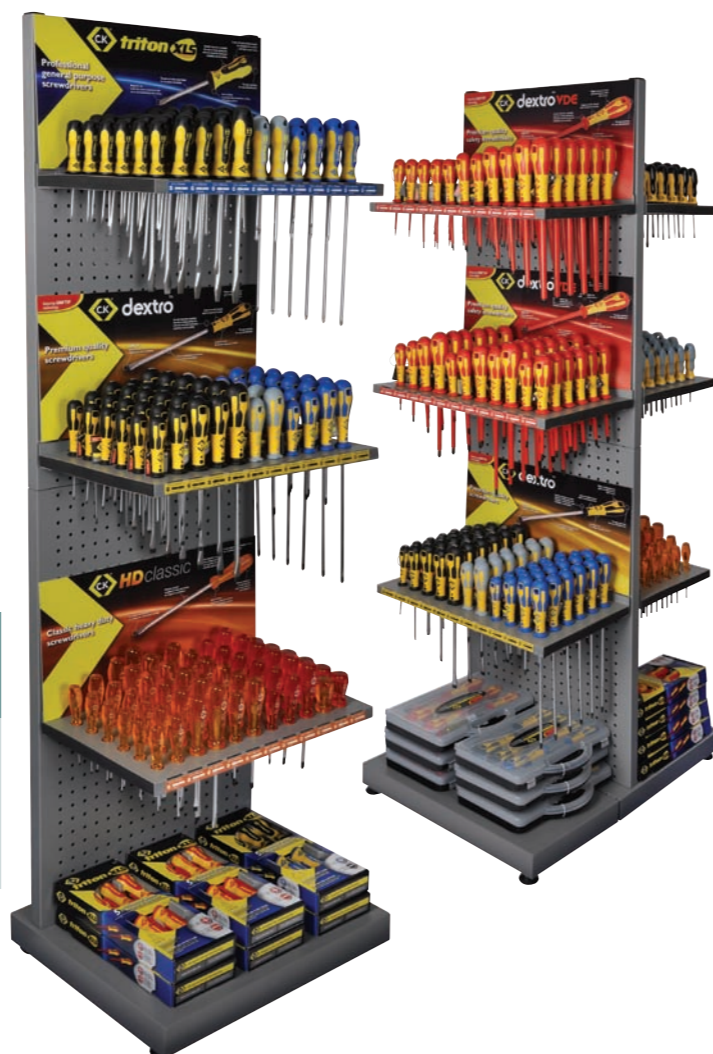

ALPHABETICAL INDEX

| PRODUCT | PAGE NUMBER |
|-----------------------|-------------|
| Engineer's hammers | 63, 109 |
| Feeler gauges | 85 |
| Files | 106-109 |
| Chain saw | 107 |
| Displays | 107 |
| Engineer's | 106 |
| File/rasp | 106 |
| Needle | 108-109 |
| Saw | 107 |
| Sets | 108 |
| Warding | 108 |
| Wood rasp | 107 |
| Filling knives | 73 |
| Finger trowels | 66-67 |
| Flat bits | 123 |
| Flat nose pliers | 149, 154 |
| Classic | 154 |
| SensoplusESD | 149 |
| Floats | 69, 72 |
| Grouting | 72 |
| Grouting sponge | 72 |
| Skimmer | 69 |
| Flooring trowels | 67 |
| Gauging trowel | 68 |
| Glass cutter | 72 |
| Glue guns | 75 |
| Glue sticks | 75 |
| Kit | 75 |
| Grouting float | 72 |
| Grouting sponge | 72 |
| Hacksaw blades | 90 |
| Hacksaws | 89-90 |
| Hammers | 61-63 |
| Ball pein | 62 |
| Brick | 62 |
| Claw | 61 |
| Club | 61 |
| Engineer's | 63 |
| Joiner's | 62 |
| Mortar pick | 62 |
| Pin | 62 |
| Sledge | 62 |
| Handsaws | 89, 90 |
| Harling trowel | 67 |
| Hexagon keys | 102-103 |
| Sets | 103 |
| Holesaws | 124-126 |
| Arbors | 124 |
| SDS-Plus | 124 |
| Kits | 126 |
| Pilot drill | 125 |
| Hose | 138 |
| Multi-Flex | 138 |
| Pro-Flex | 138 |
| Hose & tap connectors | 139-141 |

| PRODUCT | PAGE NUMBER |
|----------------------------|--------------|
| HSS drill bits | 116-119 |
| Immersion heater spanner | 70 |
| Impact driver & bits | 47 |
| Inspection lamps | 70 |
| Inspection mirrors | 162 |
| Insulated screwdriver sets | 32-44 |
| Dextro VDE | 32 |
| Triton XLS | 44 |
| Jigsaw blades | 134-135 |
| Metal | 135 |
| Universal | 135 |
| Wood | 134-135 |
| Joiner's hammers | 62 |
| Joiner's squares | 84 |
| Junior hacksaws | 90 |
| Junior hacksaw blades | 90 |
| Knives | 92-93 |
| Leaf and square tool | 69 |
| Levels | 82 |
| Line pins | 83 |
| Mainstesters | 46 |
| Margin trowel | 67 |
| Marking gauges | 84 |
| Masonry drills | 114-116 |
| SDS-Plus | 114-115 |
| Straight shank | 115-116 |
| Measuring tapes | 81 |
| Fibreglass | 81 |
| Steel | 81 |
| Surveyor's | 81 |
| Mixers & paddles | 69 |
| Drill mixers | 69 |
| Plasterer's paddle | 69 |
| Mortar pick | 62 |
| Multicutter | 25 |
| Multistep drills | 119 |
| Needle files | 108 |
| Needle nose pliers | 149, 154 |
| Classic | 154 |
| SensoplusESD | 149 |
| Nut drivers | 134 |
| Oblique cutters | 147-148, 153 |
| Classic | 153 |
| SensoplusESD | 147-148 |
| Philadelphia trowel | 66, 68 |
| Pincers | 26 |
| Pin hammers | 62 |
| Pin punches | 110 |
| Pipe cutters | 25, 70-71 |
| Copper | 70 |
| PVC | 25, 71 |
| Plasterboard saw | 90 |
| Plasterer's hawk | 69 |
| Plasterer's paddle | 69 |

| PRODUCT | PAGE NUMBER |
|--------------------------------|--------------------------|
| Plasterer's trowels | 68-69 |
| PLCC extractor | 162 |
| ESD | 162 |
| Pliers | 12-27, 149-150, 153-155 |
| Circlip | 23 |
| Combination | 13-18 |
| Classic | 17-18 |
| RedLine | 15 |
| RedLine VDE | 12-13 |
| Crimping | 21-22 |
| Flat nose | 149, 154 |
| Classic | 154 |
| SensoplusESD | 149 |
| Needle nose | 149, 154 |
| Classic | 154 |
| SensoplusESD | 149 |
| Pincers | 26 |
| Punch | 27 |
| Riveting | 24-25 |
| Accessories | 24 |
| Displays | 25 |
| Round nose | 150, 155 |
| Classic | 155 |
| SensoplusESD | 150 |
| Sets | 13, 16, 150, 155 |
| Classic | 155 |
| RedLine | 16 |
| RedLine VDE | 13 |
| SensoplusESD | 150 |
| Snipe nose | 13, 15, 18, 149, 153-154 |
| Classic | 18, 153-154 |
| RedLine | 15 |
| RedLine VDE | 13 |
| SensoplusESD | 149 |
| Tool kits | 150 |
| SensoplusESD | 150 |
| Waterpump | 18-19 |
| Wire stripping | 13, 16, 155 |
| Classic | 155 |
| RedLine | 16 |
| RedLine VDE | 13 |
| Plumb bob | 83 |
| Pocket balances | 85 |
| Pointing trowels | 66-68 |
| Prybar | 63 |
| Punches | 109-110 |
| Centre | 109 |
| Parallel | 110 |
| Set | 110 |
| Punch down tool | 57 |
| Punch pliers | 27 |
| Putty knife | 72 |
| PVC pipe cutter | 25, 71 |
| Rasp | 106-107 |
| Ratchet screwdriver sets | 46-47 |
| Ratchet screwdriver & bits set | 46-47 |
| Re-threading tools | 57 |

| PRODUCT | PAGE NUMBER |
|--------------------------------|---|
| Riveting pliers & rivets | 24-25 |
| Accessories | 24 |
| Displays | 25 |
| Set | 24 |
| Round nose pliers | 150, 155 |
| Classic | 155 |
| SensoplusESD | 150 |
| Rules | 82 |
| Aluminium | 82 |
| Steel | 82 |
| Wood | 82 |
| Saws | 89-90 |
| Blades | 89-90 |
| Coping | 89 |
| Displays | 89-90 |
| Hacksaws | 89-90 |
| Junior hacksaw | 90 |
| Mini hacksaw | 90 |
| Plasterboard (Dry wall) | 90 |
| Wood | 89 |
| Scrapers | 73 |
| Display | 73 |
| Filling knife | 73 |
| Scraper / filling knives | 73 |
| Set | 73 |
| Screwdriver bits | 127-134 |
| Accessories | 134 |
| Bit drivers | 134 |
| Sets | 129-131 |
| Standard | 127-131 |
| TiN coated | 132-133 |
| Screwdrivers | 28-47, 102-103, 164-171 |
| Dextro | 35-37 |
| Displays | 37 |
| Dextro VDE | 31-33 |
| Displays | 33 |
| HD classic | 39-41 |
| Displays | 41 |
| Hexagon keys | 102-103 |
| Impact driver & bits | 47 |
| Mainstesters | 46 |
| Precision | 167-171 |
| Ratchet screwdrivers | 46-47 |
| Sets | 32, 36, 40, 43-45, 103, 164-165, 167-168, 170-171 |
| Dextro | 36 |
| Dextro VDE | 32 |
| HD classic | 40 |
| Hexagon keys | 103 |
| Precision | 167-168, 171 |
| Ratchet screwdriver & bits set | 46-47 |
| TritonESD | 164-165 |
| Triton XLS | 44 |
| Xonic | 167-168 |
| Triton XLS | 43-45 |
| Displays | 45 |
| TritonESD | 164-165 |
| XonicESD | 170-171 |

ICON KEY

| | | | | | |
|--|--|--|------------------------------|-----------------------------|---------------------------------|
| | Size | | Screwdriver blade length | | Hexagon key |
| | Piano wire | | Screwdriver handle length | | Cupboard key |
| | Hard wire | | Hexagon key long arm length | | Flattened round |
| | Medium wire | | Hexagon key short arm length | | Tapered square |
| | Soft wire | | Weight | | Tape blade width |
| | Information | | Lifting capacity | | Tape blade width |
| | Approved & independently audited by the German VDE Institute | | Slotted tip | | Rule width |
| | Conforms to IEC 60900:2004 | | Pozi (PZ) tip | | Half round file |
| | GS tested & certified for safety | | Phillips (PH) tip | | Flat file |
| | ESD (IEC 61340-5-1 compliant) | | Modulo tip | | Round file |
| | Diameter | | TX tip | | Triangular file |
| | Conforms to DIN standards | | TX tamperproof tip | | Square file |
| | Mild steel (standard) | | Hexagon tip | | Half round rasp |
| | High tensile steel (standard) | | Shank diameter | | Flat rasp |
| | Blade direction | | Bolster chisel blade width | | Flat file/rasp |
| | Round jaw | | Finger trowel blade width | | Cutting thickness |
| | Flat jaw | | Tooth width | | Thread pitch |
| | Parallel jaw | | WEEE compliant | WC | Tungsten-carbide cutting edges |
| | Coax crimp | | Saw blade pitch | TYPE | Type |
| | Ferrule crimp | | Teeth per inch | | Standard cut |
| | Ferrule crimp | | Spanner size | | Full flush cut |
| | Insulated crimp | | Square key - Large | | Extra full flush cut |
| | Non insulated crimp | | Square key - Medium | | Serrated jaws |
| | Modular crimp | | Square key - Small | | Smooth jaws |
| | Slotted blade length | | Triangular key - Large | | Box quantity |
| | Slotted blade width | | Triangular key - Medium | mm² / AWG | Wire size |
| | | | Triangular key - Small | BOSCH | Equivalent Bosch item reference |

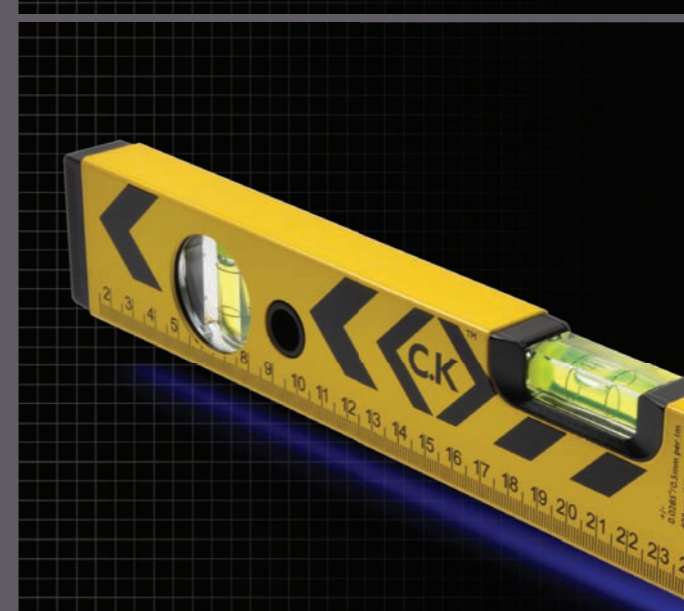
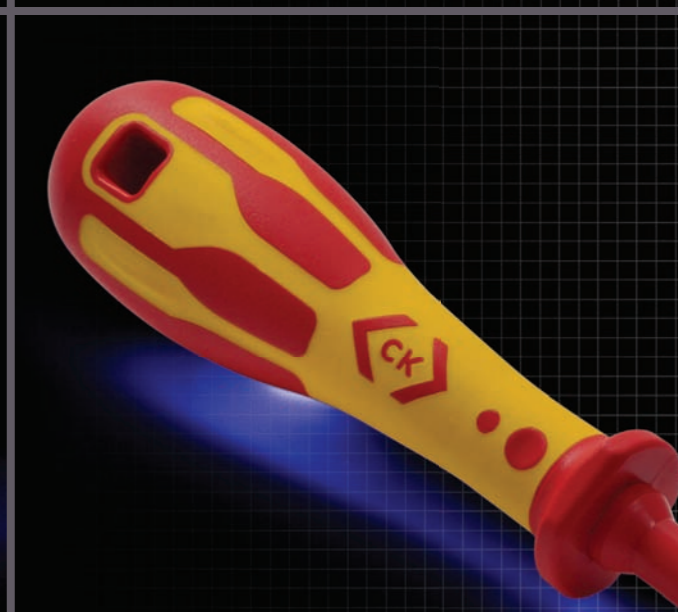
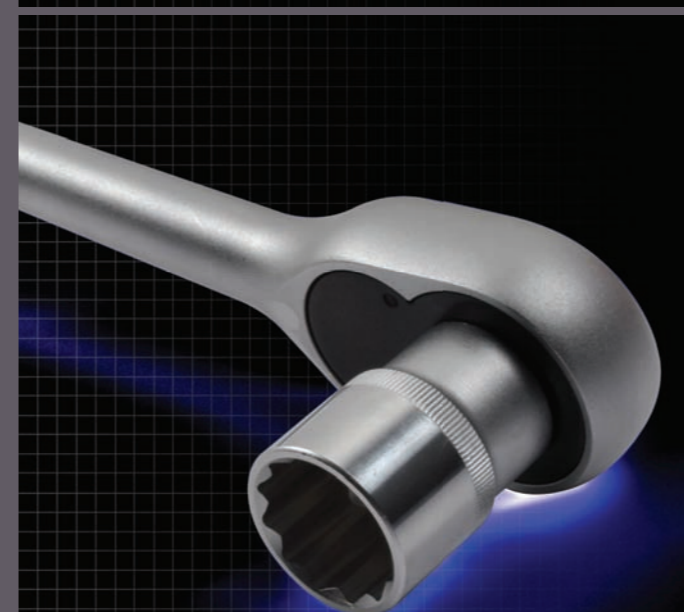
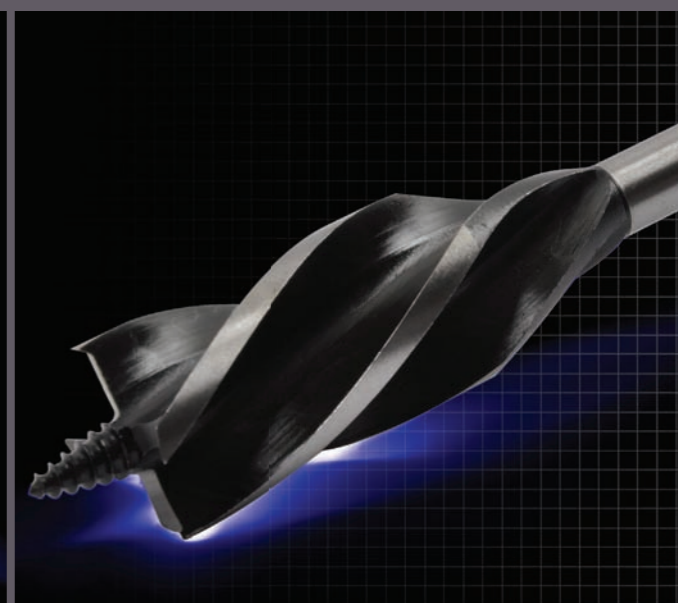
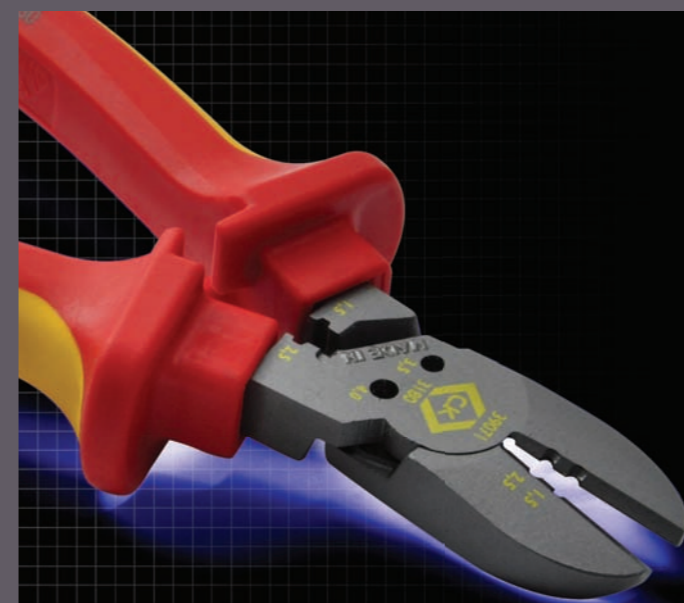

Carl
Kammerling
International

Brand
Innovation

Head Office:

United Kingdom
Carl Kammerling International Ltd.
Pwllheli, LL53 5LH
Tel: +44 (0)1758 701070
Fax: +44 (0)1758 704777
email: sales@cki.uk.com

www.carlkammerling.com

Carl Kammerling International's
Distribution Partners:

Republic of Ireland
Tel: 1-800818 660
Fax: 1-800818 659
email: dublin-sales@cki.uk.com

Germany and Rest Of World
Carl Kämmerling GmbH & Co. KG
Bendahler Str. 110,
42285 Wuppertal

Tel: +49 (0) 202.89030
Fax: +49 (0) 202.890322
email: info@cki.de.com

USA
C.K North America Inc.
52 Eisenhower Lane North
Lombard IL 60148
Tel: +1 (866) 484.5943
Fax: +1 (630) 953.2686
email: ckusanick@aol.com

France
Tel: +33 (0) 810 000044
Fax: +33 (0) 810 000357
email: info@cki.de.com

Carl Kammerling International Ltd. reserves the right to alter products and / or specifications without prior notice. Prices are correct at time of printing E. & O.E. All trademarks are acknowledged. All photographs are for guidance only and do not necessarily represent the products illustrated.

©2011. Published by Carl Kammerling International Ltd. No part of this publication may be produced without prior permission from Carl Kammerling International Ltd.

M4011ENG 10k / 01-11